



ARCHITECTURAL RACEWAY MOLDING

Steel Molding
Indoor Plastic Molding
Outdoor Plastic Molding





Multilink started its innovative journey in 1983 and has grown into one of the largest manufacturers of CATV product solutions. Providing many different solutions, we pride ourselves on being one of the most versatile manufacturers in the industry. We do this by working closely with our customers to provide the most innovative solutions to fit their demands.

Technologies and markets continually change, we know that and are here to adapt to those changes. It is our core responsibility, at Multilink, to build the right product to meet your needs while maintaining the premium quality you expect. Our engineering department works closely with our research and development department to ensure our core responsibilities.

With an adaptive business practices we look forward to continue our growth in the years to come, providing many more innovative solutions to our customers.



Multilink proudly engineers and manufactures our products in the USA with our headquarters based in Elyria, Ohio.



We stand behind the quality of our products. Following Six Sigma processes ensures quality in everything we do.

OTHER OFFERINGS



POWER SUPPLIES

Various power solutions for any Fiber Deep and MDU applications. Our power supplies are manufactured in house and we provide full installation training to help installations run efficiently.

We design and manufacture custom cabinets daily. Let our engineering department design your next cabinet for your network needs.

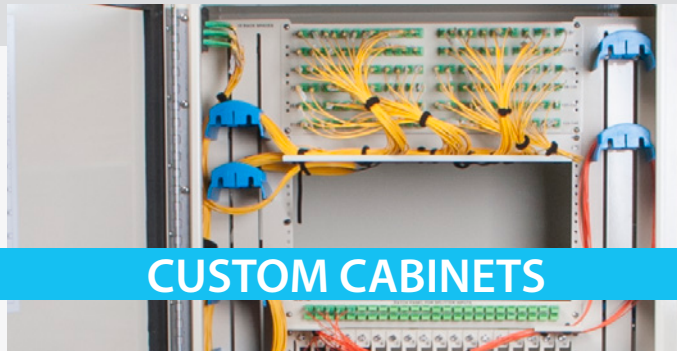

CUSTOM CABINETS



FTTX SOLUTIONS

Our FTTX solutions provide numerous solution for your network. Our lineup includes aerial, pedestal, vault and indoor/outdoor network solutions.

We offer factory or field terminated products on various custom fiber assemblies. All in house assemblies are terminated and tested to meet Telcordia quality standards.



FIBER

STEEL MOLDING **6**

STEEL MOLDING7

.5" STEEL MOLDING8

.75" STEEL MOLDING 10

1.25" STEEL MOLDING 13

2" STEEL MOLDING 17

3" STEEL MOLDING 22

INDOOR PLASTIC **26**

MICRO MOLDING™ 27

MICRO MOLDING™ 28

LATCH DUCT MOLDING 31

MRM75 32

MRM12 35

MRM17 38

MULTICLEAR SURFACE RACEWAY 41

MRC75 42

MRC12 45

MRC17 48

MRC30 51

COVE MOLDING 53

2" COVE MOLDING 54

2.75" COVE MOLDING 55

QUARTER ROUND 56

QUARTER ROUND 57

HINGED OVERLAY 59

HINGED OVERLAY 60

FLAT BOX 62

.75" FLAT BOX 63

1.25" FLAT BOX.....	64
2" FLAT BOX.....	65
2.5" FLAT BOX	66

OUTDOOR PLASTIC **67**

DOWNSPOUT **68**

<i>DOWNSPOUT</i>	69
------------------------	-----------

MULTICLEAR EXTERIOR **71**

<i>MRC12-E</i>	72
<i>MRC17-E</i>	75
<i>MRC30-E</i>	78

6 | STEEL MOLDING

STEEL MOLDING	7
<i>.5" STEEL MOLDING</i>	8
<i>.75" STEEL MOLDING</i>	10
<i>1.25" STEEL MOLDING</i>	13
<i>2" STEEL MOLDING</i>	17
<i>3" STEEL MOLDING</i>	22



Steel Molding

Multilink's metal molding provides clean cable routing. The metal molding lineup includes everything from straight run pieces to angle and corner pieces. All parts and pieces are manufactured by Multilink right in the USA. We stand by the quality of our products against many things such as cracking and warping. The longevity of our molding will provide many years of operational use.

.5" Steel Molding

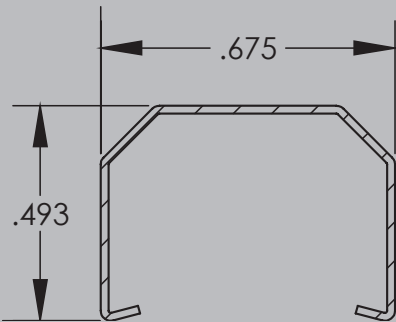
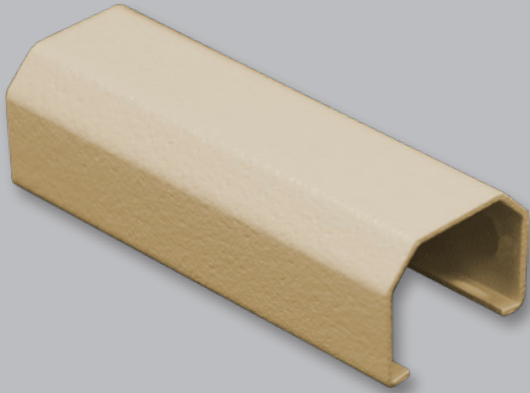

Molding - 8ft.
800 ft. / Carton

White	038-034-10
Beige	038-034-20
Brown	038-034-30
Brick Red	038-034-40



Mounting Bracket - 4 in.
10 / Pack

038-036-20

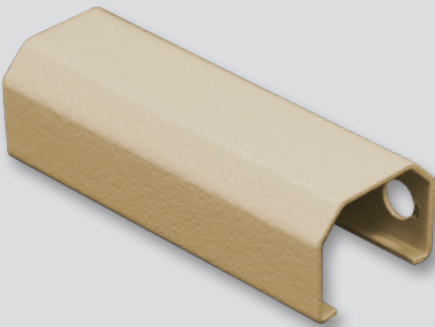

Seam Cover
10 / Pack

White	038-035-10
Beige	038-035-20
Brown	038-035-30
Brick Red	038-035-40



End Cap
10 / Pack

White	038-037-10
Beige	038-037-20
Brown	038-037-30
Brick Red	038-037-40

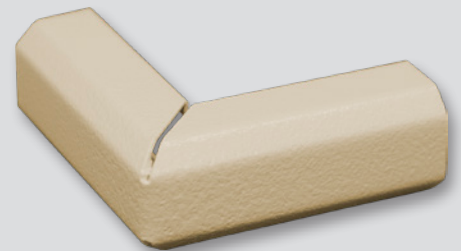

Outside Elbow
10 / Pack

White	038-038-10
Beige	038-038-20
Brown	038-038-30
Brick Red	038-038-40



T Fitting

10/Pack

White	038-040-10
Beige	038-040-20
Brown	038-040-30
Brick Red	038-040-40



Flat Elbow

10/Pack

White	038-041-10
Beige	038-041-20
Brown	038-041-30
Brick Red	038-041-40



Inside Elbow

10/Pack

White	038-042-10
Beige	038-042-20
Brown	038-042-30
Brick Red	038-042-40



Touch Up Paint

Each

White	12718
Beige	12720
Brown	12715
Brick Red	12717



Entry Tool

Each

33800



Cutting Tool

Each

33815

.75" Steel Molding

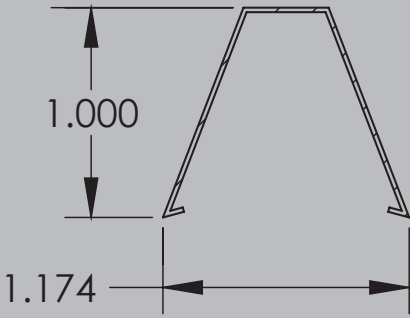
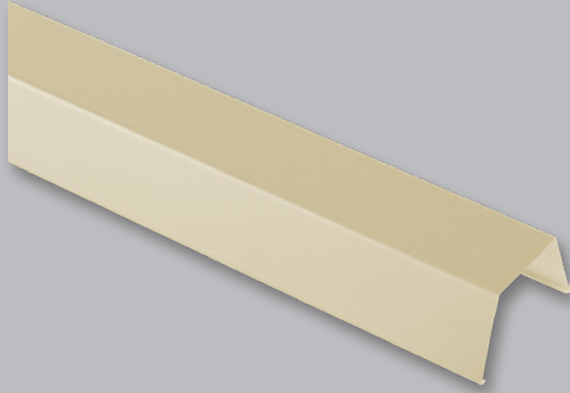

Molding - 8ft.
224 ft. / Carton

White	20115
Beige	20117
Brown	20118
Brick Red	20119

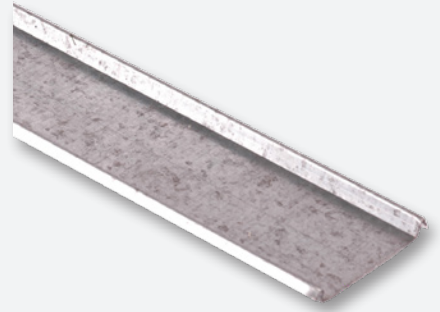

Mounting Bracket - 8ft.
224 ft. / Carton

25913

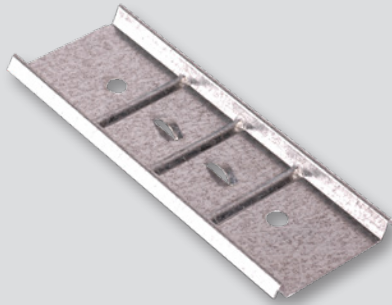

5" Mounting Bracket
10 / Pack

25912

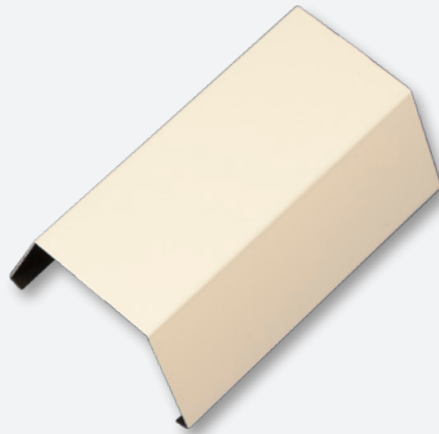

Seam Cover
10 / Pack

White	25920
Beige	25917
Brown	25918
Brick Red	25919

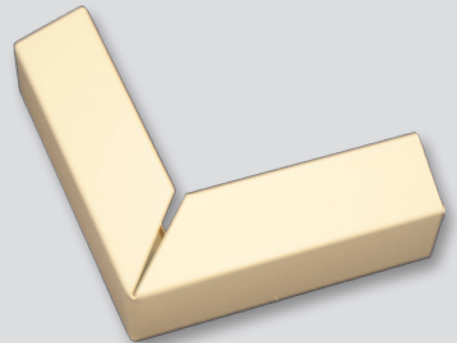

Outside Elbow
10 / Pack

White	27326
Beige	25117
Brown	25118
Brick Red	25119

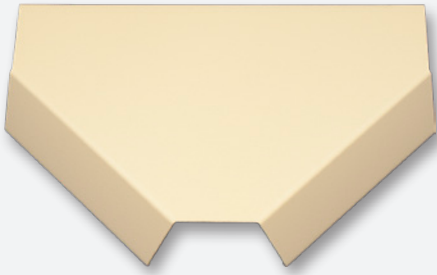

T Fitting

10/Pack

White	25420
Beige	25417
Brown	25418
Brick Red	25419



Flat Elbow

10/Pack

White	27329
Beige	25217
Brown	25218
Brick Red	25219



Inside Elbow

10/Pack

White	27323
Beige	25017
Brown	25018
Brick Red	25019



Bell Flange

10/Pack

White	27321
Beige	25617
Brown	25618
Brick Red	25619



Touch Up Paint

Each

White	12718
Beige	12720
Brown	12715
Brick Red	12717



Entry Tool

Each

33800



Cutting Tool

Each

33815



1.25" Steel Molding

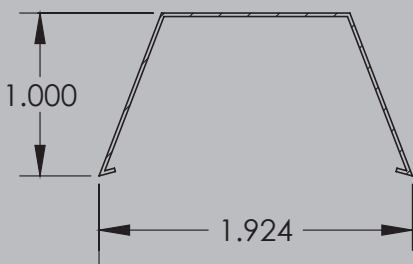
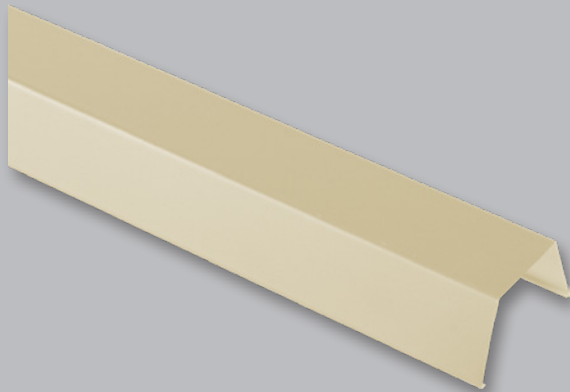

Molding - 8ft.

224 ft. / Carton

White	20136
Beige	20137
Brown	20138
Brick Red	20139

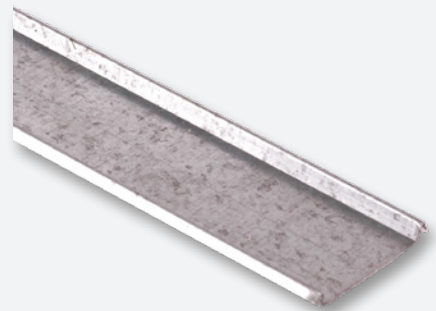

Mounting Bracket - 8ft.

224 ft. / Carton

25933

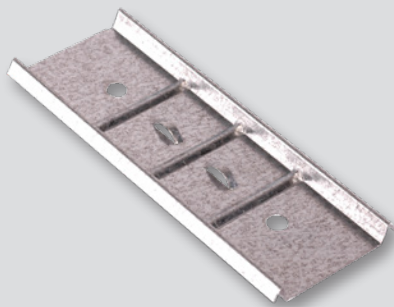

5" Mounting Bracket

10 / Pack

25932

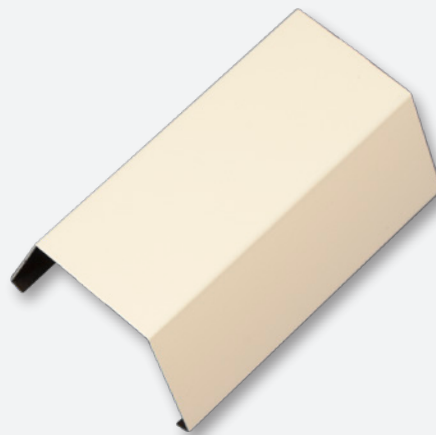

Seam Cover

10 / Pack

White	25940
Beige	25937
Brown	25938
Brick Red	25939

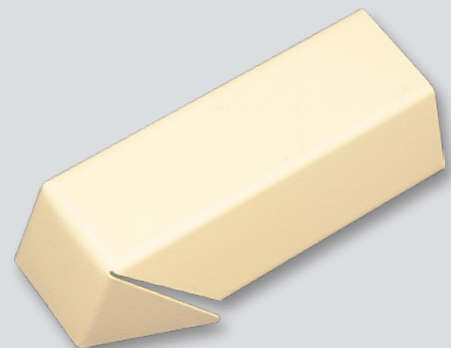

End Cap

10 / Pack

White	27333
Beige	25337
Brown	25338
Brick Red	25339

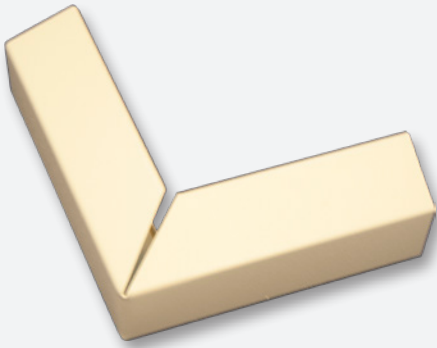

Outside Elbow

10 / Pack

White	27327
Beige	25137
Brown	25138
Brick Red	25139

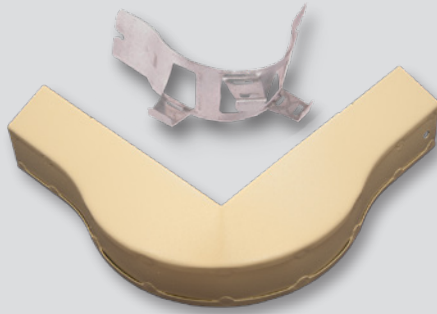

Outside Elbow w/ Bend Radius

10 / Pack

White	10-9301
Beige	10-9303
Brown	10-9302
Brick Red	10-9304

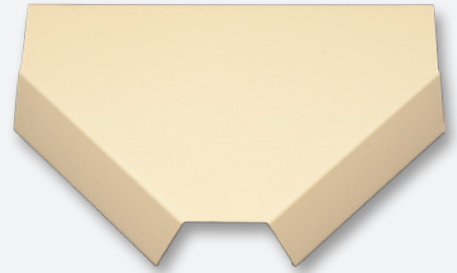

T Fitting

10 / Pack

White	25440
Beige	25437
Brown	25438
Brick Red	25439

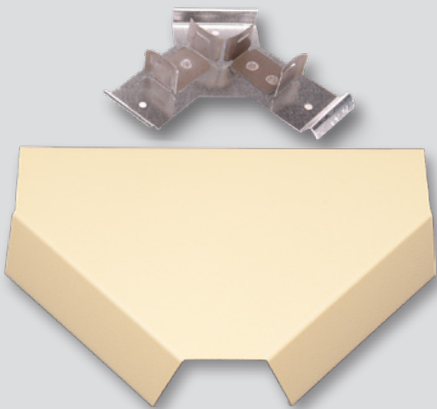

T Fitting w/ Bend Radius

10 / Pack

White	10-9280
Beige	10-9282
Brown	10-9281
Brick Red	10-9283



Flat Elbow

10 / Pack

White	27330
Beige	25237
Brown	25238
Brick Red	25239



Flat Elbow w/ Bend Radius

10 / Pack

White	10-9276
Beige	10-9278
Brown	10-9277
Brick Red	10-9279



Inside Elbow

10/Pack

White	27324
Beige	25037
Brown	25038
Brick Red	25039

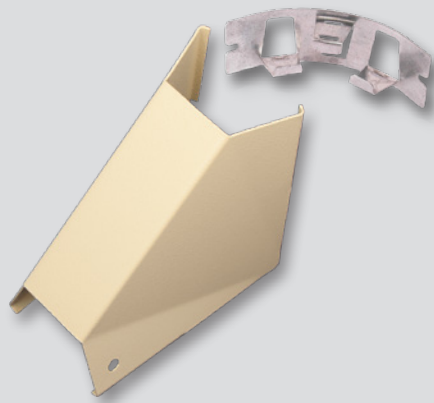

Inside Elbow w/ Bend Radius

10/Pack

White	10-9293
Beige	10-9295
Brown	10-9294
Brick Red	10-9296



Bell Flange

10/Pack

White	25636
Beige	25637
Brown	25638
Brick Red	25639



Entry Hoof

10/Pack

White	10-9309
Beige	10-9311
Brown	10-9310
Brick Red	10-9312



Touch Up Paint

Each

White	12718
Beige	12720
Brown	12715
Brick Red	12717



Entry Tool

Each

33800



Cutting Tool

Each

33815



2" Steel Molding

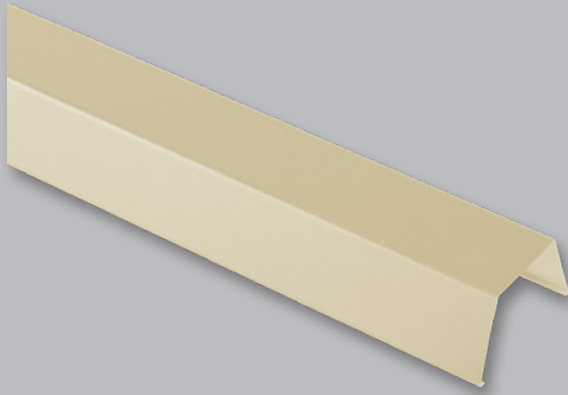

Molding - 8ft.

192 ft. / Carton

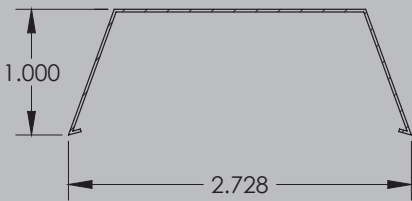

White	20171
Beige	20167
Brown	20168
Brick Red	20169

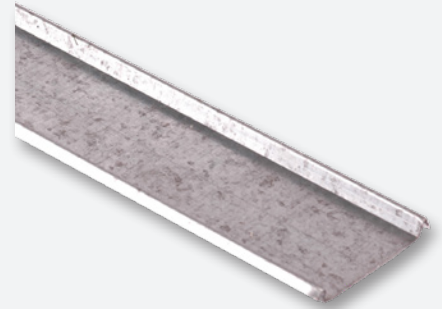

Mounting Bracket - 8ft.

224 ft. / Carton

25993

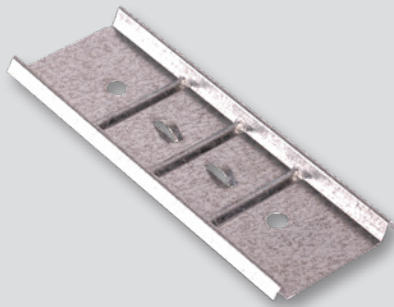

5" Mounting Bracket

10 / Pack

25962

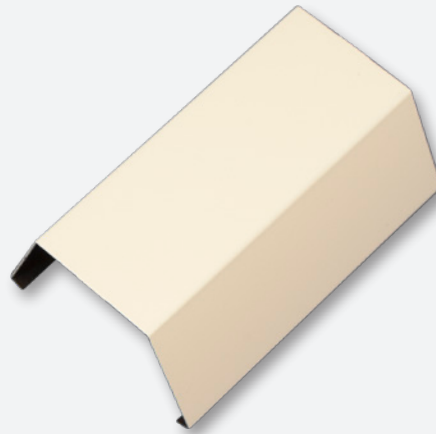

Seam Cover

10 / Pack

White	25961
Beige	25967
Brown	25968
Brick Red	25969

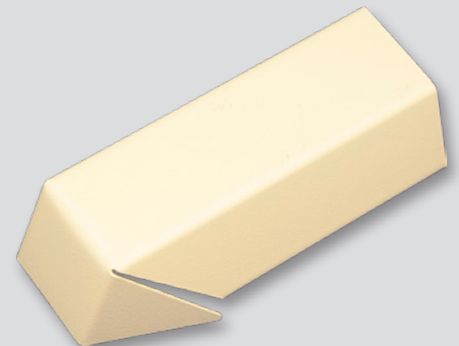

End Cap

10 / Pack

White	27334
Beige	25367
Brown	25368
Brick Red	25369

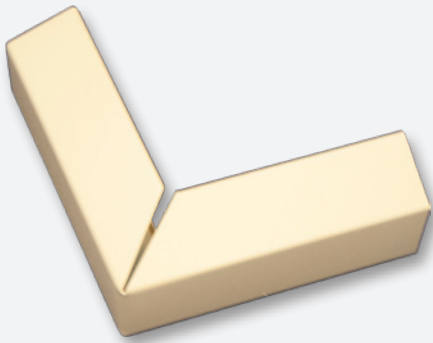

Outside Elbow

10 / Pack

White	27328
Beige	25167
Brown	25168
Brick Red	25169

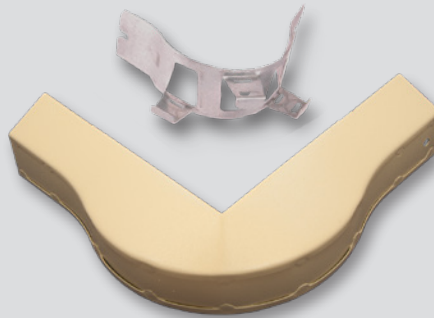

Outside Elbow w/ Bend Radius

10 / Pack

White	10-9305
Beige	10-9307
Brown	10-9306
Brick Red	10-9308

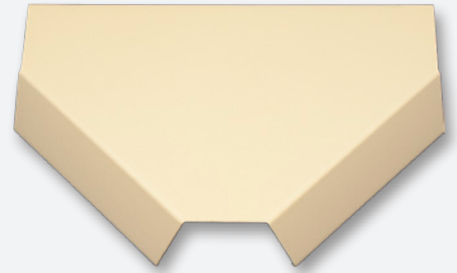

T Fitting

10 / Pack

White	25466
Beige	25467
Brown	25468
Brick Red	25469

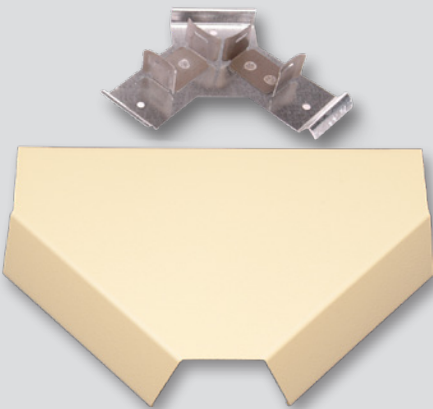

T Fitting w/ Bend Radius

10 / Pack

White	10-9288
Beige	10-9290
Brown	10-9289
Brick Red	10-9291



Flat Elbow

10 / Pack

White	27331
Beige	25267
Brown	25268
Brick Red	25269



Flat Elbow w/ Bend Radius

10 / Pack

White	10-9284
Beige	10-9286
Brown	10-9285
Brick Red	10-9287



Inside Elbow

10/Pack

White	27325
Beige	25067
Brown	25068
Brick Red	25069

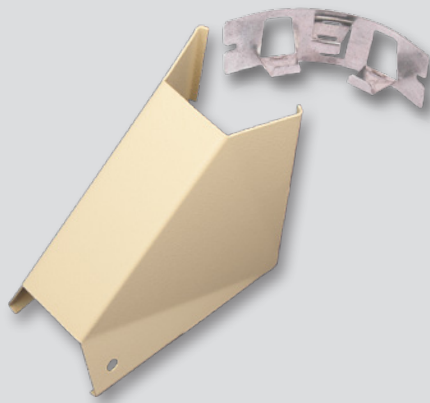

Inside Elbow w/ Bend Radius

10/Pack

White	10-9297
Beige	10-9299
Brown	10-9298
Brick Red	10-9300



Bell Flange

10/Pack

White	27322
Beige	25667
Brown	25668
Brick Red	25669



Entry Hoof

10/Pack

White	10-9313
Beige	10-9315
Brown	10-9314
Brick Red	10-9316

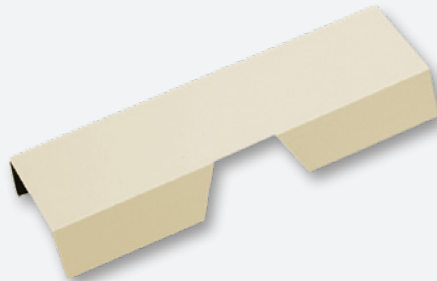

T Reducer

10/Pack

White	25566
Beige	25567
Brown	25568
Brick Red	25569

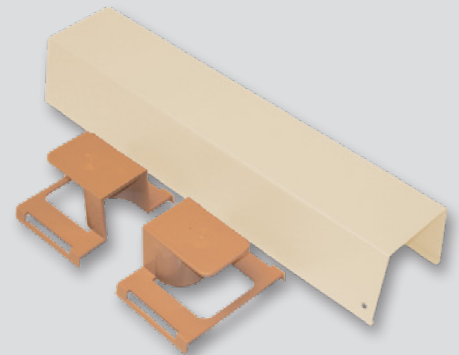

In Line Spool

Each

White	038-008-23
Beige	038-008-22
Brown	038-008-24
Brick Red	038-008-21



4 Way Fitting

10/Pack

White	038-007-23
Beige	038-007-22
Brown	038-007-24
Brick Red	038-007-21



Transition Box

Each

White	045-095-10
Beige	045-094-10
Brown	045-096-10
Brick Red	045-097-10



Butterfly Clip

Each

33900



Flush Wall Entry Plug

Each

649-022-22



Touch Up Paint

Each

White	12718
Beige	12720
Brown	12715
Brick Red	12717



Entry Tool

Each

33800



Cutter Tool

Each

33815



3" Steel Molding

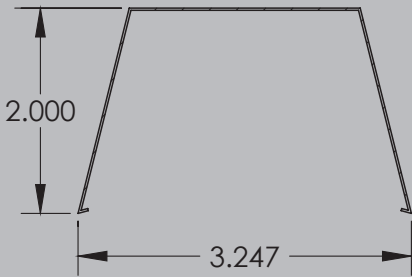
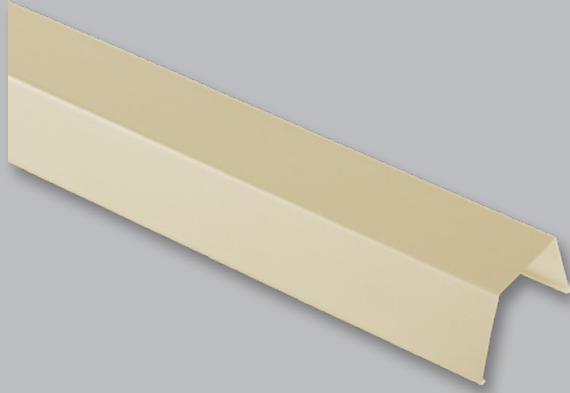

Molding - 8ft.

96 ft. / Carton

White	20197
Beige	20194
Brown	20196
Brick Red	20195

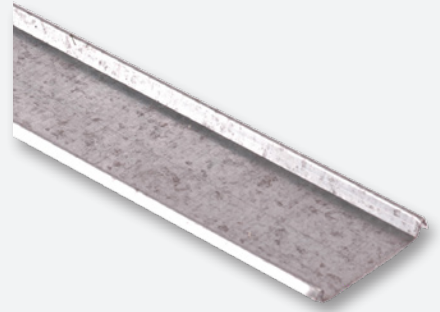

Mounting Bracket - 8ft.

96 ft. / Carton

25934

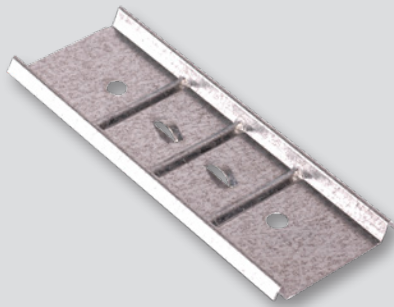

5" Mounting Bracket

10 / Pack

25963

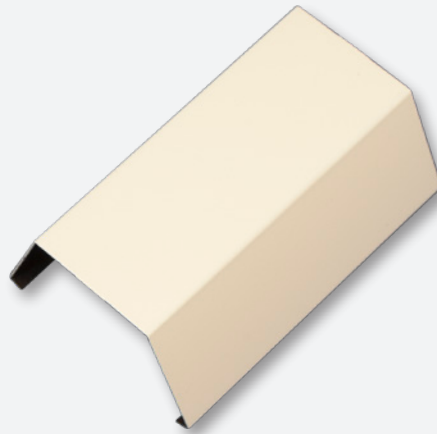

Seam Cover

10 / Pack

White	25007
Beige	25009
Brown	25109
Brick Red	25008

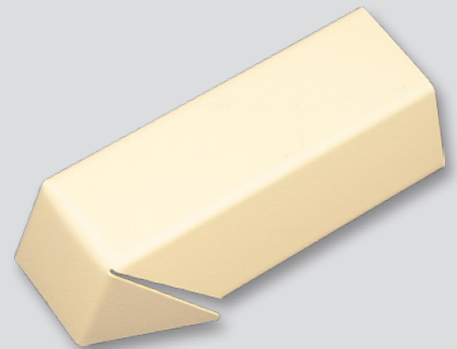

End Cap

10 / Pack

White	25005
Beige	25396
Brown	25394
Brick Red	25395

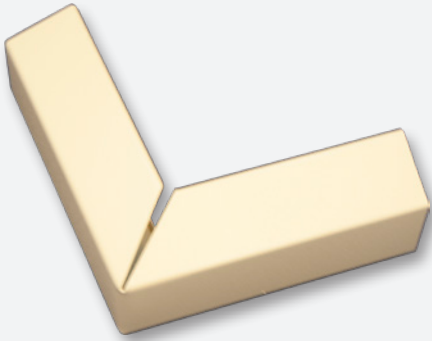

Outside Elbow

10/Pack

White	25002
Beige	25194
Brown	25196
Brick Red	25195

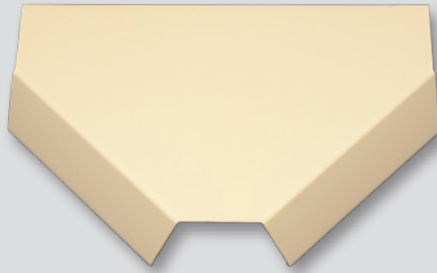

T Fitting

10/Pack

White	25006
Beige	25494
Brown	25496
Brick Red	25495



Flat Elbow

10/Pack

White	25003
Beige	25294
Brown	25296
Brick Red	25295



Inside Elbow

10/Pack

White	25001
Beige	25096
Brown	25094
Brick Red	25095



Bell Flange

10/Pack

White	25004
Beige	25694
Brown	25696
Brick Red	25695

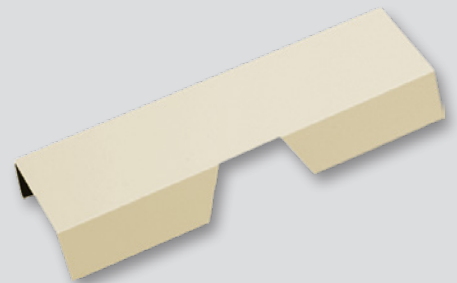

T Reducer

10/Pack

White	25593
Beige	25594
Brown	25596
Brick Red	25595

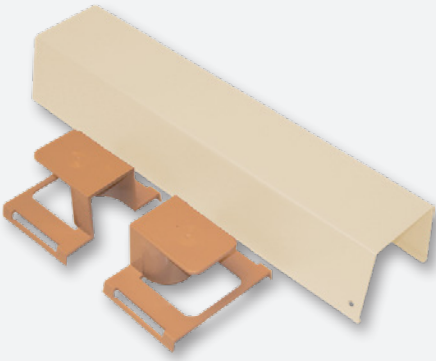

In Line Pool

Each

White	038-009--23
Beige	038-009-22
Brown	038-009-24
Brick Red	038-009-21



4 Way Fitting

10/Pack

White	038-005-23
Beige	038-005-22
Brown	038-005-24
Brick Red	038-005-21



Transition Box

Each

White	045-090-11
Beige	045-090-10
Brown	045-090-12
Brick Red	045-090-13



Butterfly Clip

Each

33900



Flush Wall Entry Plug

Each

649-022-22



Touch Up Paint

Each

White	12718
Beige	12720
Brown	12715
Brick Red	12717



Entry Tool

Each

33800



Cutter Tool

Each

33815



MICRO MOLDING™	27
<i>MICRO MOLDING™</i>	28
LATCH DUCT MOLDING	31
<i>MRM75</i>	32
<i>MRM12</i>	35
<i>MRM17</i>	38
MULTICLEAR SURFACE RACEWAY	41
<i>MRC75</i>	42
<i>MRC12</i>	45
<i>MRC17</i>	48
<i>MRC30</i>	51
COVE MOLDING	53
2" <i>COVE MOLDING</i>	54
2.75" <i>COVE MOLDING</i>	55
QUARTER ROUND	56
<i>QUARTER ROUND</i>	57
HINGED OVERLAY	59
<i>HINGED OVERLAY</i>	60
FLAT BOX	62
.75" <i>FLAT BOX</i>	63
1.25" <i>FLAT BOX</i>	64
2" <i>FLAT BOX</i>	65
2.5" <i>FLAT BOX</i>	66



Micro Molding™

Micro Molding™ is a compact design for Multi Dwelling Units (MDU's) and commercial fiber building applications for interior use. The Micro Molding™ is designed to house up to 12 900µm fibers. A 3MM single fiber molding is also available.

Micro Molding™

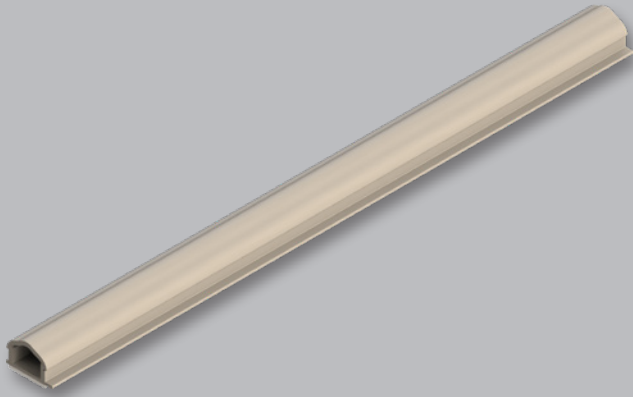

Molding - 8ft.

600 ft. / Carton

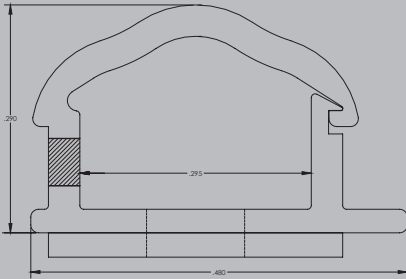

White	039-643-11
Beige	039-643-10



Molding w/ Adhesive Backing - 8ft.

600 ft. / Carton

White	039-642-11
Beige	039-642-10

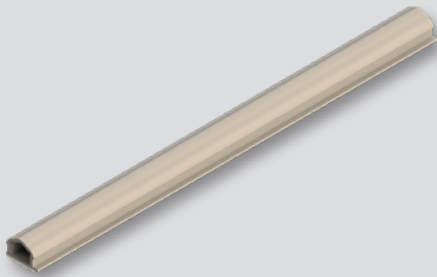

Molding - 3MM Fiber - 8ft.

600 ft. / Carton

White	10-9404
Beige	10-9405

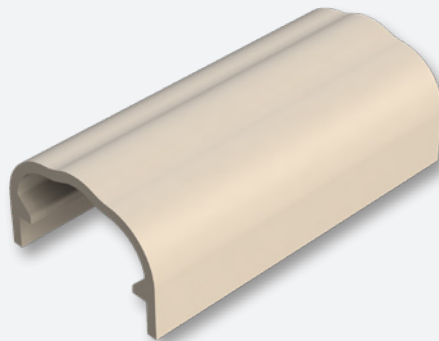

Seam Cover

10 / Pack

White	649-222-21
Beige	649-222-20

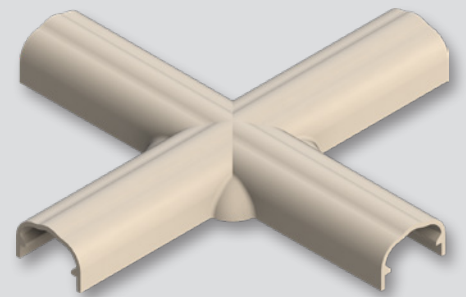

4 Way Fitting

10 / Pack

White	649-227-21
Beige	649-227-20

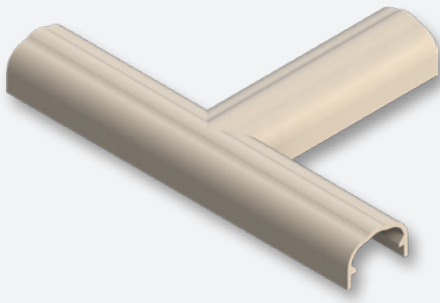

3 Way Fitting

10/Pack

White	649-226-21
Beige	649-226-20

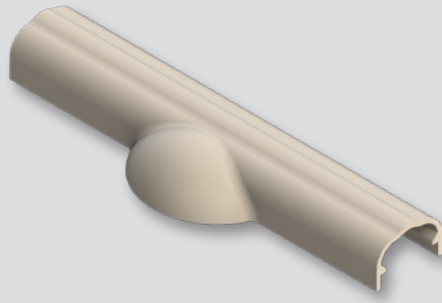

Access Deployment Cap

10/Pack

White	649-225-21
Beige	649-225-20

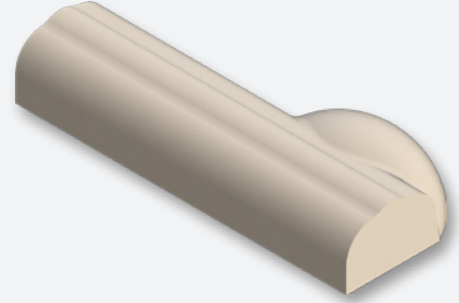

Access Deployment Left End

10/Pack

White	649-228-21
Beige	649-228-20

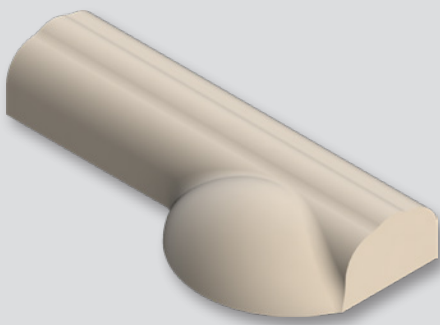

Access Deployment Right End

10/Pack

White	649-224-21
Beige	649-224-20

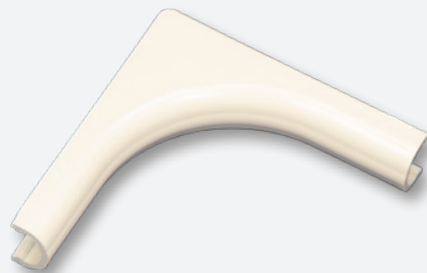

Inside Corner

10/Pack

White	10-9406
Beige	10-9407



Outside Corner

10/Pack

White	10-9408
Beige	10-9409



Flat Elbow

10/Pack

White	10-9411
Beige	10-9410

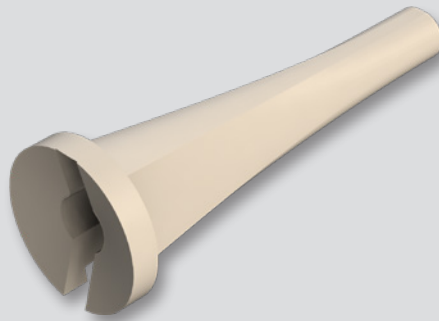

Fiber Feeder Plug

10/Pack

White	649-223-21
Beige	649-223-20

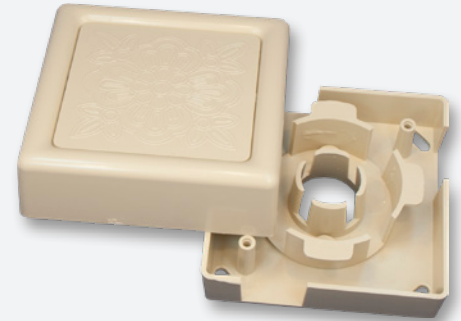

3" Slack Storage Box w/ Knockouts

Each

White	020-050-10
Beige	10-9434

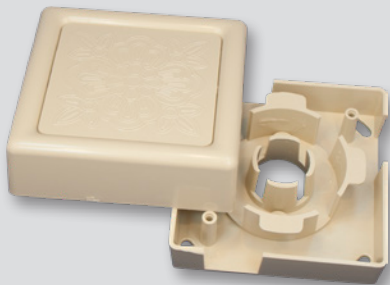

6" Slack Storage Box w/ Knockouts

Each

White	020-026-12
Beige	020-026-11

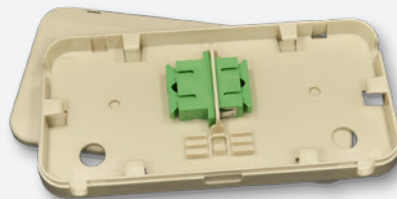

Fiber Wall Plate

Each

White	065-773-13
Beige	065-773-11

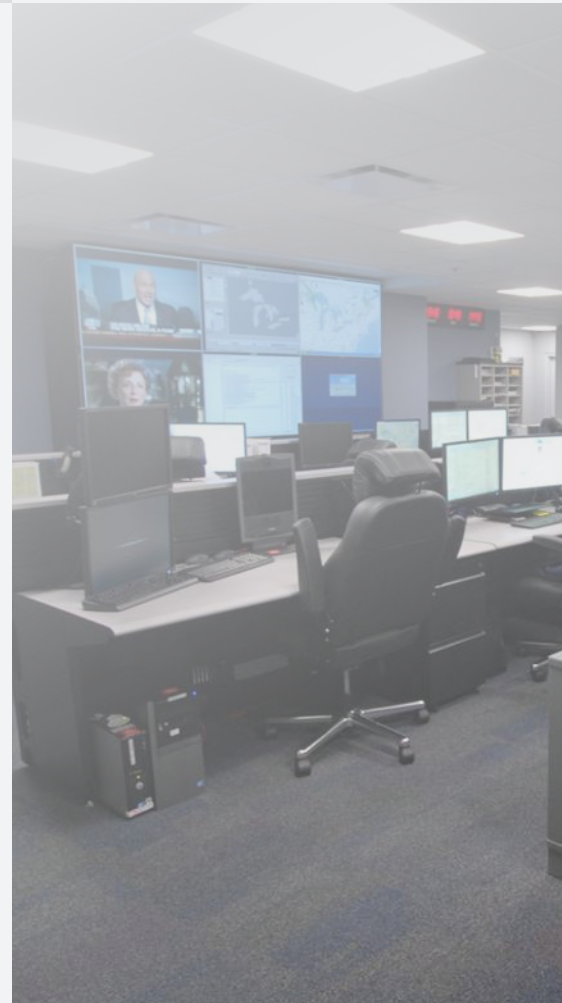



Latch Duct Molding

Multilink's Latch Duct Interior Plastic Raceway System is a 1 piece design that hinges open for installation access. The molding can be used to route and protect cabling for low voltage data, voice, video, and fiber optic applications. Fittings are available for routing direction changes, extending, and terminating the molding. All bases incorporate a 1" minimum bend radius as recommended for fiber optic cables. The molding is manufactured using a special purpose profile extrusion alloy resin and the fittings are manufactured using an injection grade resin. The product can be painted with latex paint.

MRM75

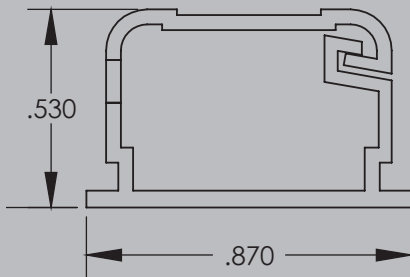

Molding - 6ft.
120 ft. / Carton

White	99825
Ivory	99828
Office White	99830



Ceiling Entry
10 / Pack

White	99321K
Ivory	99319K
Office White	99322K

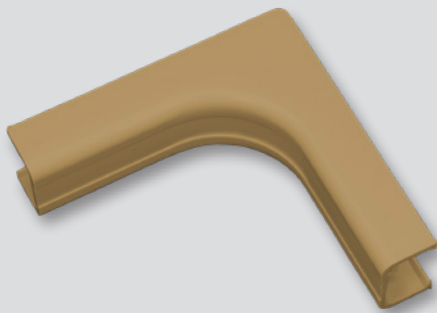

Inside Corner
10 / Pack

White	99454K
Ivory	99459K
Office White	99455K



T Fitting
10 / Pack

White	99616K
Ivory	99615K
Office White	99614K

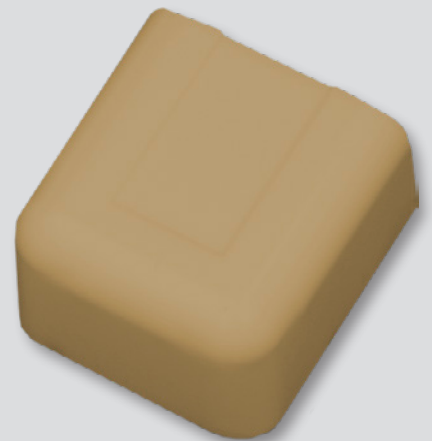

End Cap
10 / Pack

White	99646K
Ivory	99645K
Office White	99647K



Outside Corner

10/Pack

White	99442K
Ivory	99441K
Office White	99443K

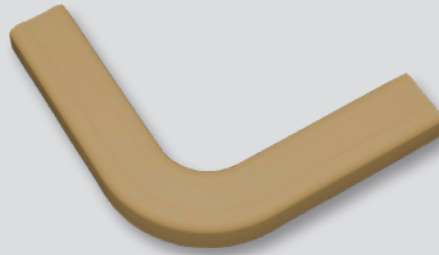

Flat Elbow

10/Pack

White	99487K
Ivory	99486K
Office White	99485K



Seam Cover

10/Pack

White	99412K
Ivory	99411K
Office White	99413K

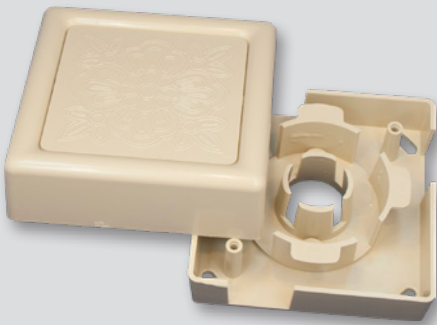

**3" Slack Storage Box w/
Knockouts**

Each

White	020-050-10
Ivory	10-9434
Office White	10-9433

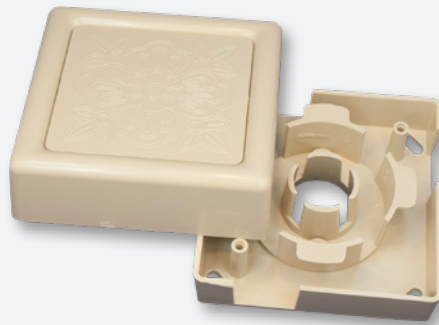

**6" Slack Storage Box w/
Knockouts**

Each

White	020-026-12
Ivory	020-026-11
Office White	020-026-10

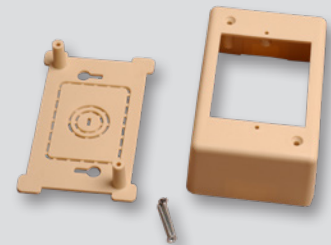

**Surface Mount Junction
Box - Single Gang**

Each

White	99581K
Ivory	99580K
Office White	99584K

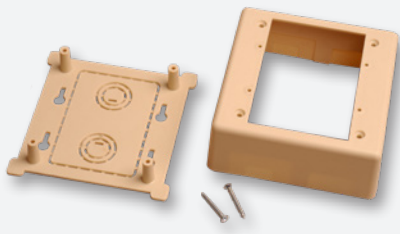

**Surface Mount Junction
Box - Double Gang**
Each

White	99583K
Ivory	99582K
Office White	99585K

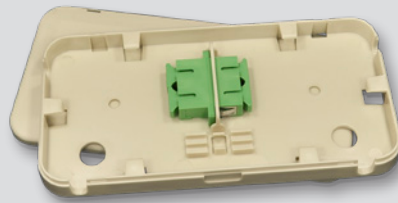

Fiber Wall Plate
Each

White	065-773-13
Ivory	065-773-11
Office White	65-773-12



MRM12



Molding - 6ft.
120 ft. / Carton

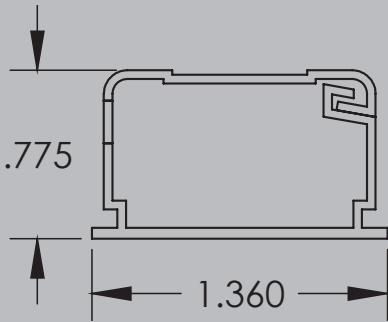

White	99835
Ivory	99838
Office White	99831



Ceiling Entry
10 / Pack

White	99323K
Ivory	99320K
Office White	99324K

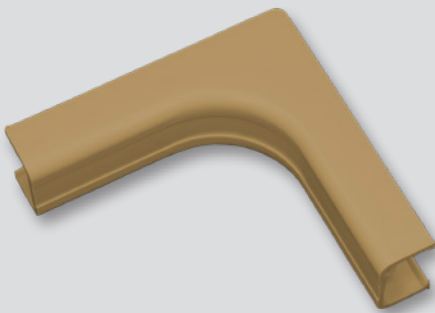

Inside Corner
10 / Pack

White	99465K
Ivory	99463K
Office White	99460K



Seam Cover
10 / Pack

White	99417K
Ivory	99416K
Office White	99418K

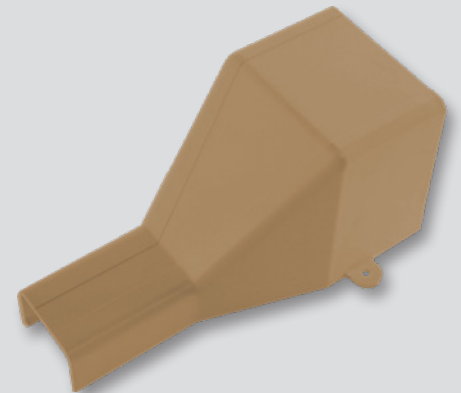

Transition Fitting
10 / Pack

White	649-069-21
Ivory	649-069-20
Office White	649-069-22



End Cap

10/Pack

White	99652K
Ivory	99651K
Office White	99653K



Outside Corner

10/Pack

White	99447K
Ivory	99446K
Office White	99445K

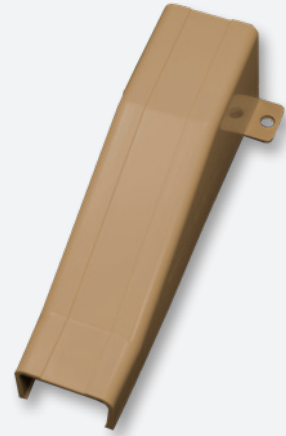

Slack Box Entry

10/Pack

White	99412K
Ivory	99411K
Office White	99413K

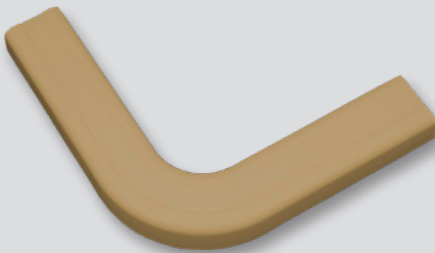

Flat Elbow

10/Pack

White	99492K
Ivory	99491K
Office White	99490K



Reducer Fitting

10/Pack

White	99631K
Ivory	99630K
Office White	99632K

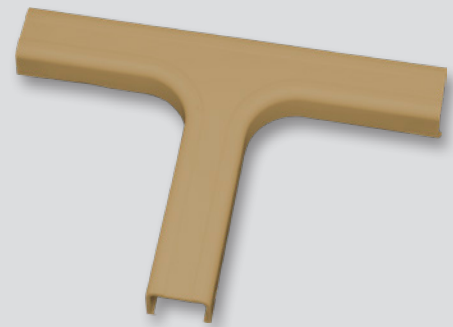

T Fitting

10/Pack

White	99621K
Ivory	99620K
Office White	99623K

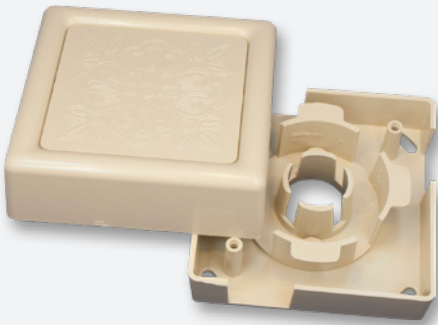

3" Slack Storage Box w/ Knockouts

Each

White	020-050-10
Ivory	10-9434
Office White	10-9433



6" Slack Storage Box w/ Knockouts

Each

White	020-026-12
Ivory	020-026-11
Office White	020-026-10

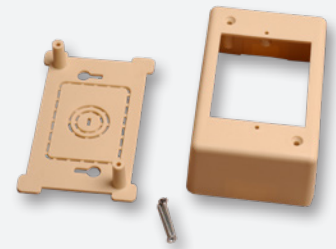

Surface Mount Junction Box - Single Gang

Each

White	99581K
Ivory	99580K
Office White	99584K

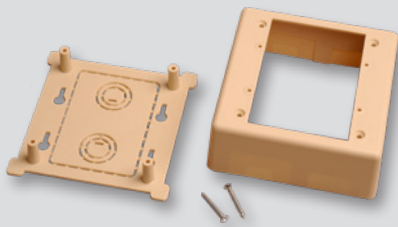

Surface Mount Junction Box - Double Gang

Each

White	99583K
Ivory	99582K
Office White	99585K

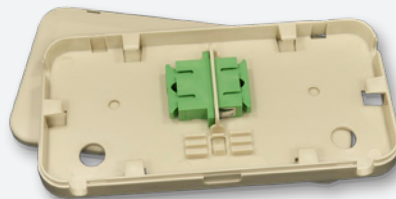

Fiber Wall Plate

Each

White	065-773-13
Ivory	065-773-11
Office White	065-773-12

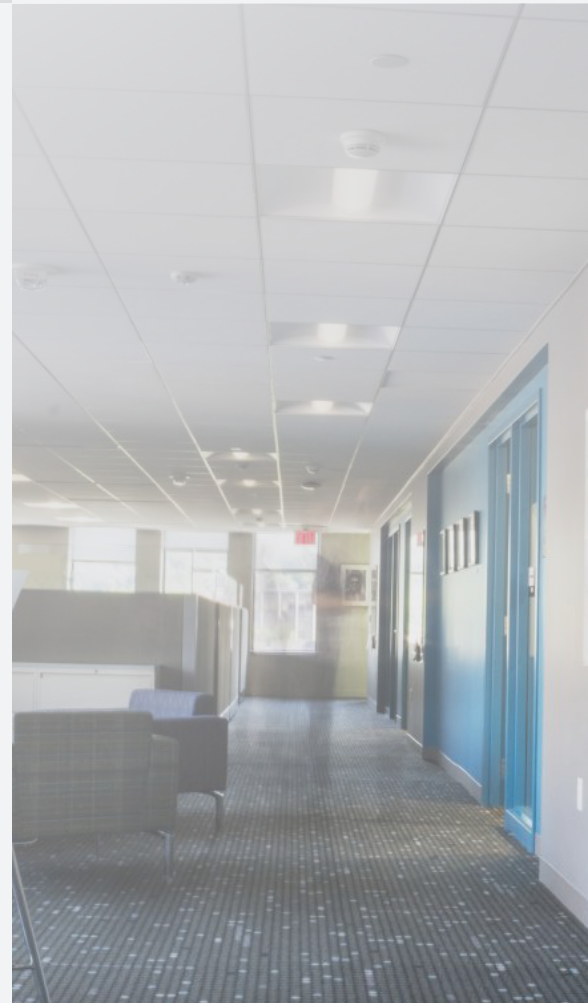

MRM17

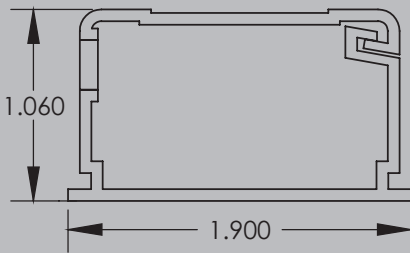

Molding - 6ft.

120 ft. / Carton

White	99845
Ivory	99848
Office White	99832



Ceiling Entry

10 / Pack

White	99331K
Ivory	99330K
Office White	99332K

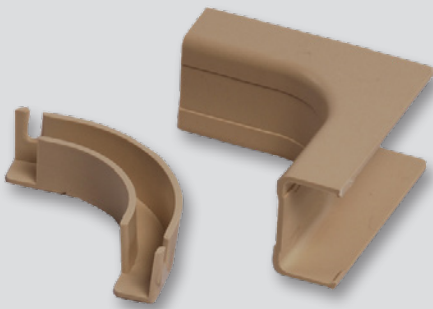

Inside Corner

10 / Pack

White	99470K
Ivory	99469K
Office White	99475K



Seam Cover

10 / Pack

White	99422K
Ivory	99421K
Office White	99423K

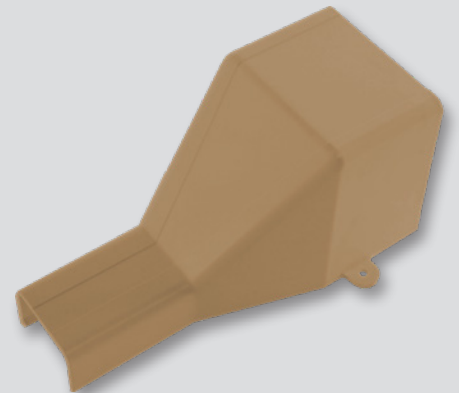

Transition Fitting

10 / Pack

White	649-051-23
Ivory	649-051-21
Office White	649-051-22



End Cap

10/Pack

White	99657K
Ivory	99656K
Office White	99658K

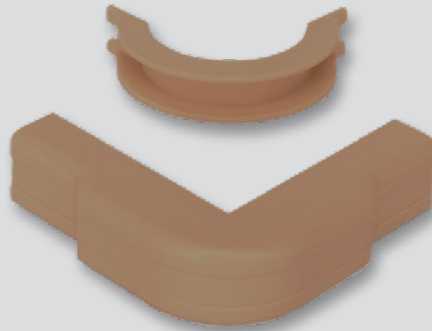

Outside Corner

10/Pack

White	99452K
Ivory	99451K
Office White	99450K



Slack Box Entry

10/Pack

White	039-285-20
Ivory	039-307-20
Office White	039-306-20

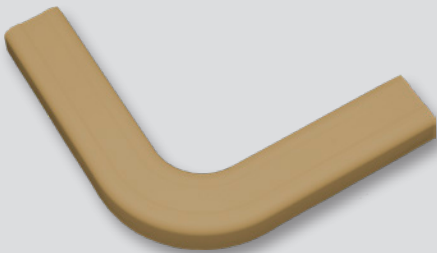

Flat Elbow

10/Pack

White	99497K
Ivory	99496K
Office White	99495K

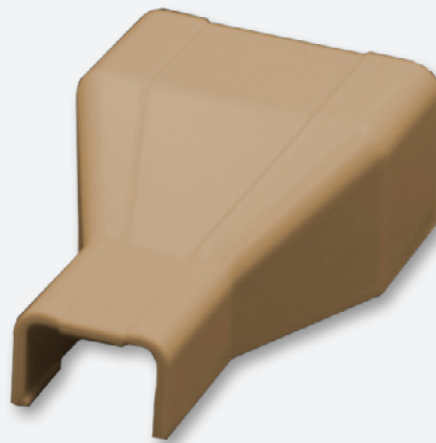

**Reducer Fitting
to .75"**

10/Pack

White	99636K
Ivory	99635K
Office White	99637K



T Fitting

10/Pack

White	99626K
Ivory	99625K
Office White	99624K

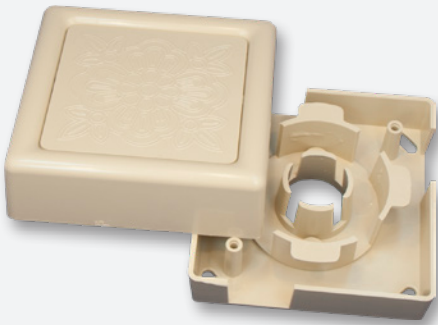

**3" Slack Storage Box w/
Knockouts**

Each

White	020-050-10
Ivory	10-9434
Office White	10-9433

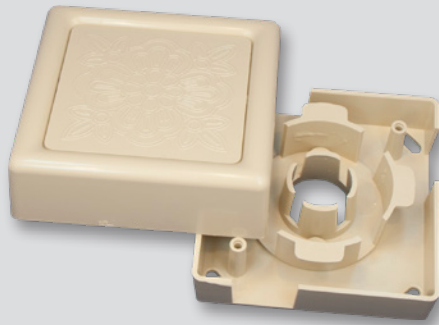

**6" Slack Storage Box w/
Knockouts**

Each

White	020-026-12
Ivory	020-026-11
Office White	020-026-10

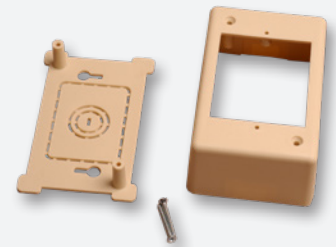

**Surface Mount Junction
Box - Single Gang**

Each

White	99581K
Ivory	99580K
Office White	99584K

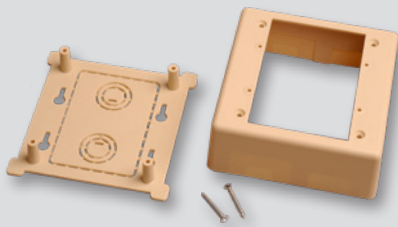

**Surface Mount Junction
Box - Double Gang**

Each

White	99583K
Ivory	99582K
Office White	99585K

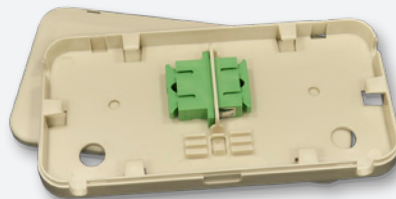

Fiber Wall Plate

Each

White	065-773-13
Ivory	065-773-11
Office White	065-773-12





MultiClear Surface Raceway

Multilink's Plastic Track Molding is a 2 piece design with a base cover. The molding can be used to route and protect cabling for low voltage data, voice, video, and fiber optic applications. Fittings are available for routing direction changes, extensions, and termination of the molding. All bases incorporate a 1" minimum bend radius as recommended for fiber optic cables. The molding is manufactured using a special purpose profile extrusion alloy resin and the fittings are manufactured using an injection grade resin. The product is easily painted with latex paint.

MRC75

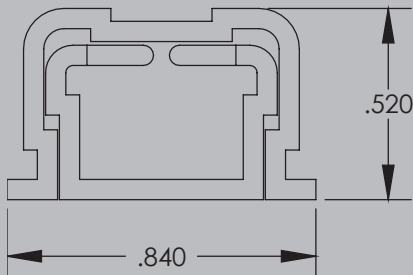
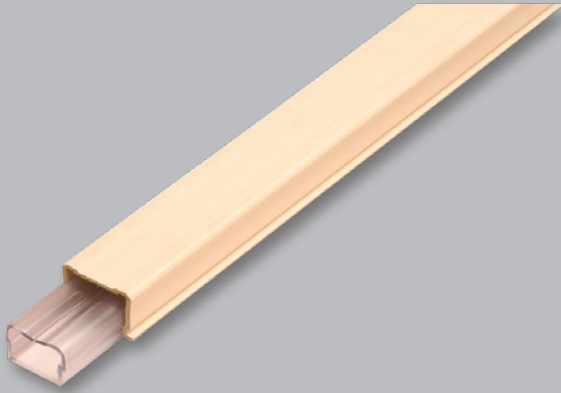

Molding - 6ft.
120 ft. / Carton

White	99855
Ivory	99854
Office White	039-549-10



Ceiling Entry
10 / Pack

White	99321K
Ivory	99319K
Office White	99322K

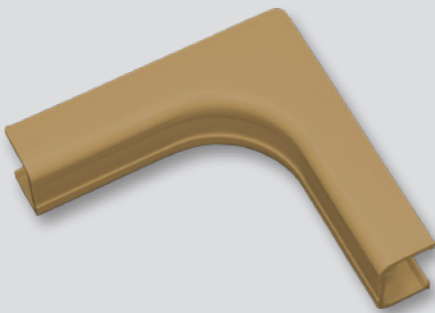

Inside Corner
10 / Pack

White	99454K
Ivory	99459K
Office White	99455K



T Fitting
10 / Pack

White	99616K
Ivory	99615K
Office White	99614K

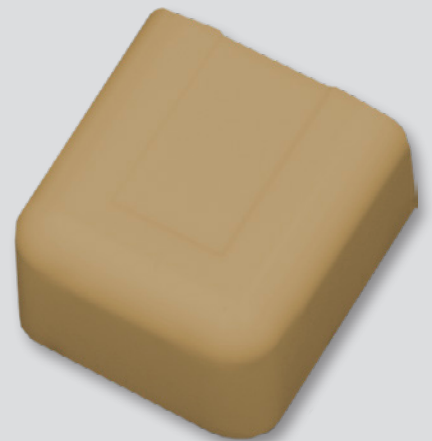

End Cap
10 / Pack

White	99646K
Ivory	99645K
Office White	99647K



Outside Corner

10/Pack

White	99442K
Ivory	99441K
Office White	99443K

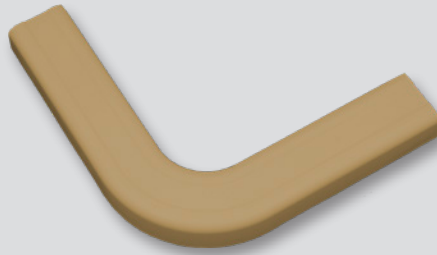

Flat Elbow

10/Pack

White	99487K
Ivory	99486K
Office White	99485K



Seam Cover

10/Pack

White	99412K
Ivory	99411K
Office White	99413K

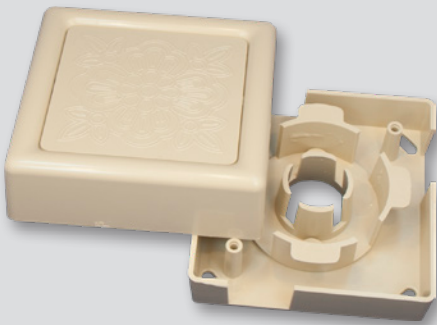

**3" Slack Storage Box w/
Knockouts**

Each

White	020-050-10
Ivory	10-9434
Office White	10-9433



**6" Slack Storage Box w/
Knockouts**

Each

White	020-026-12
Ivory	020-026-11
Office White	020-026-10

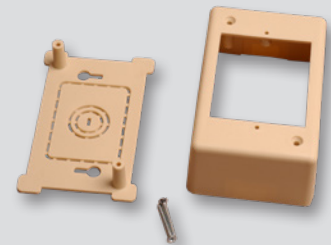

**Surface Mount Junction
Box - Single Gang**

Each

White	99581K
Ivory	99580K
Office White	99584K

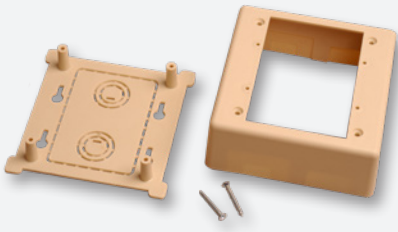

**Surface Mount Junction
Box - Double Gang**
Each

White	99583K
Ivory	99582K
Office White	99585K

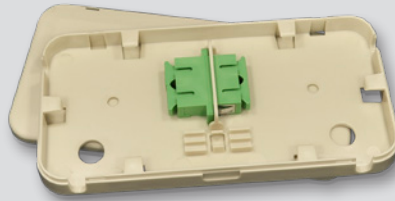

Fiber Wall Plate
Each

White	065-773-13
Ivory	065-773-11
Office White	65-773-12



MRC12

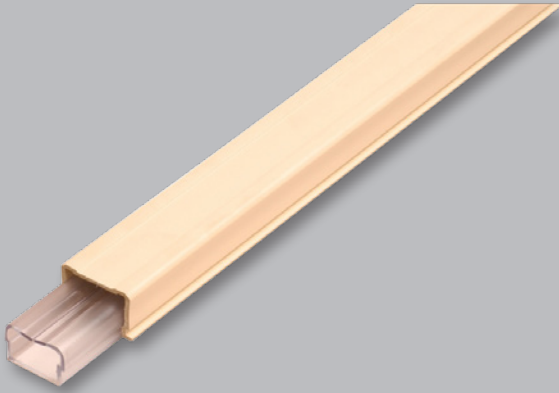

Molding - 6ft.
120 ft. / Carton

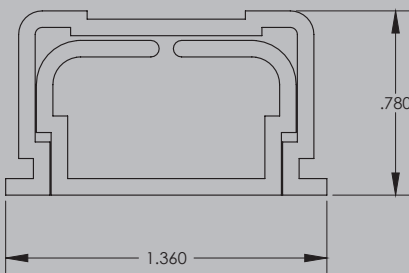

White	99861
Ivory	99860
Office White	039-595-10



Ceiling Entry
10 / Pack

White	99323K
Ivory	99320K
Office White	99324K

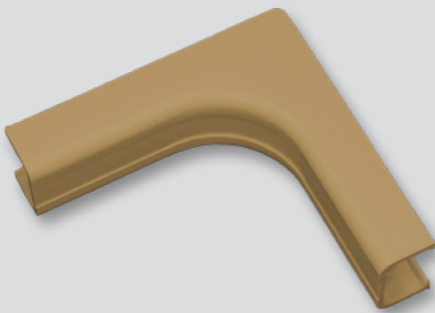

Inside Corner
10 / Pack

White	99465K
Ivory	99463K
Office White	99460K



Seam Cover
10 / Pack

White	99417K
Ivory	99416K
Office White	99418K

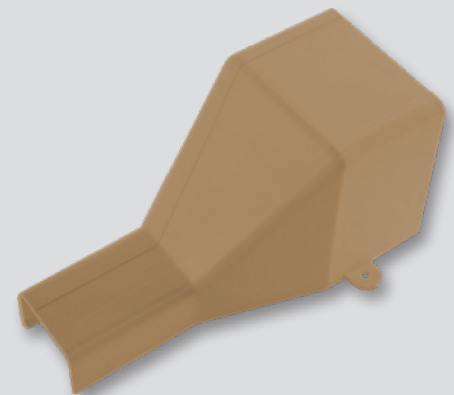

Transition Fitting
10 / Pack

White	649-069-21
Ivory	649-069-20
Office White	649-069-22



End Cap

10/Pack

White	99652K
Ivory	99651K
Office White	99653K



Outside Corner

10/Pack

White	99447K
Ivory	99446K
Office White	99445K



Slack Box Entry

10/Pack

White	99412K
Ivory	99411K
Office White	99413K

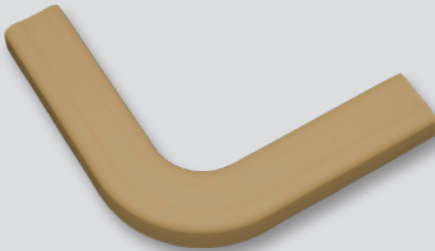

Flat Elbow

10/Pack

White	99492K
Ivory	99491K
Office White	99490K



Reducer Fitting

10/Pack

White	99631K
Ivory	99630K
Office White	99632K

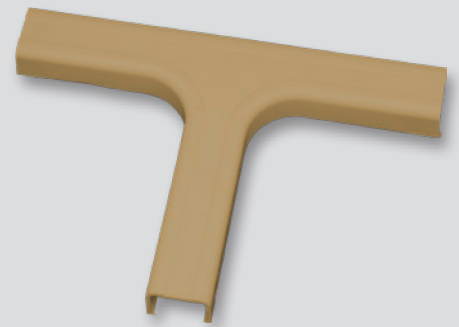

T Fitting

10/Pack

White	99621K
Ivory	99620K
Office White	99623K

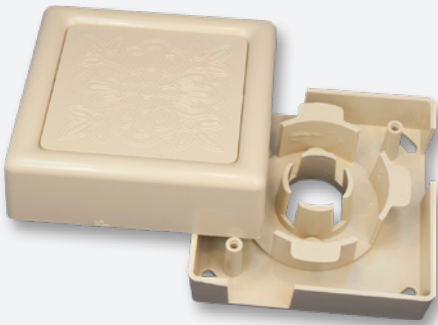

3" Slack Storage Box w/ Knockouts

Each

White	020-050-10
Ivory	10-9434
Office White	10-9433

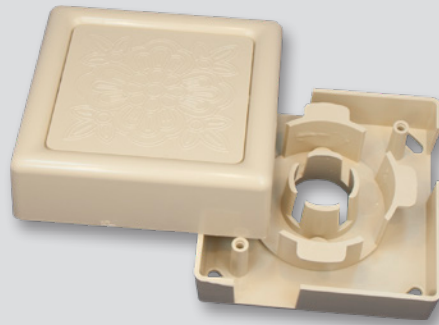

6" Slack Storage Box w/ Knockouts

Each

White	020-026-12
Ivory	020-026-11
Office White	020-026-10

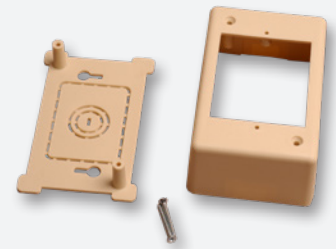

Surface Mount Junction Box - Single Gang

Each

White	99581K
Ivory	99580K
Office White	99584K

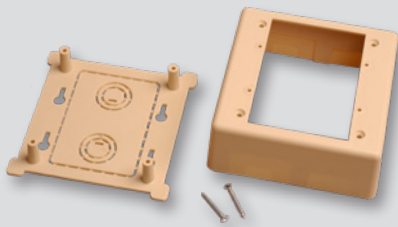

Surface Mount Junction Box - Double Gang

Each

White	99583K
Ivory	99582K
Office White	99585K

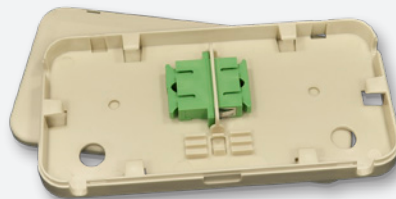

Fiber Wall Plate

Each

White	065-773-13
Ivory	065-773-11
Office White	065-773-12



MRC17

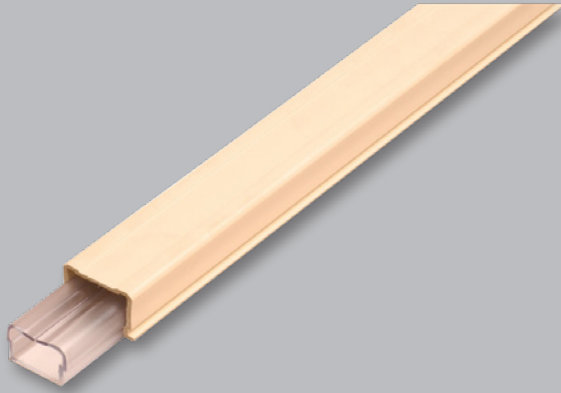

Molding - 6ft.
120 ft. / Carton

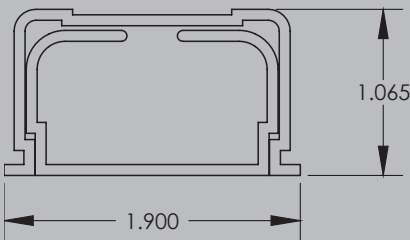

White	99867
Ivory	99866
Office White	99869



Ceiling Entry
10 / Pack

White	99331K
Ivory	99330K
Office White	99332K

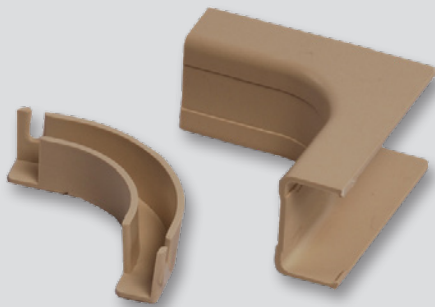

Inside Corner
10 / Pack

White	99470K
Ivory	99469K
Office White	99475K



Seam Cover
10 / Pack

White	99422K
Ivory	99421K
Office White	99423K

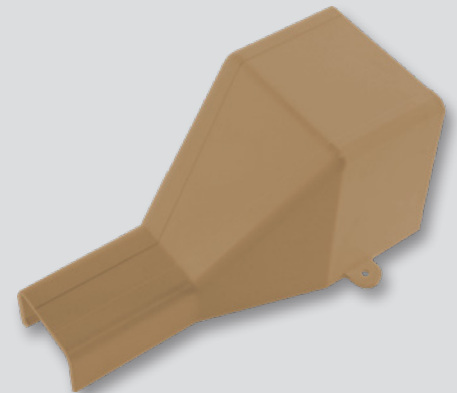

Transition Fitting
10 / Pack

White	649-051-23
Ivory	649-051-21
Office White	649-051-22



End Cap

10/Pack

White	99657K
Ivory	99656K
Office White	99658K

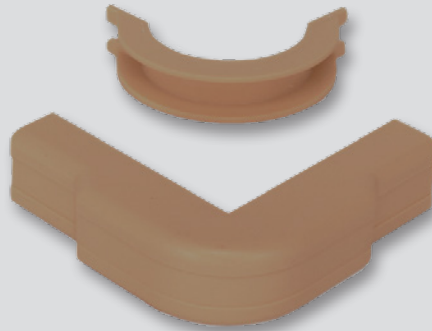

Outside Corner

10/Pack

White	99452K
Ivory	99451K
Office White	99450K



Slack Box Entry

10/Pack

White	039-285-20
Ivory	039-307-20
Office White	039-306-20

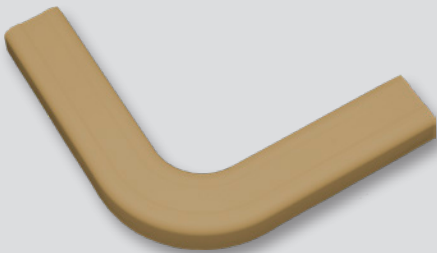

Flat Elbow

10/Pack

White	99497K
Ivory	99496K
Office White	99495K



**Reducer Fitting
to .75"**

10/Pack

White	99636K
Ivory	99635K
Office White	99637K



T Fitting

10/Pack

White	99626K
Ivory	99625K
Office White	99624K

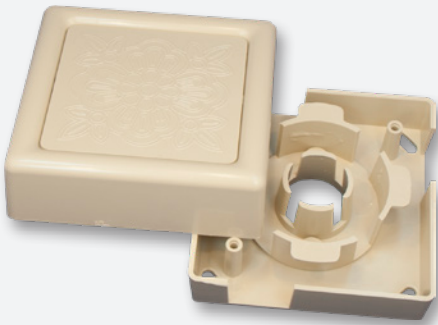

3" Slack Storage Box w/ Knockouts

Each

White	020-050-10
Ivory	10-9434
Office White	10-9433

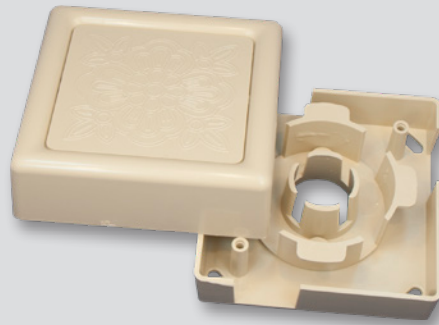

6" Slack Storage Box w/ Knockouts

Each

White	020-026-12
Ivory	020-026-11
Office White	020-026-10

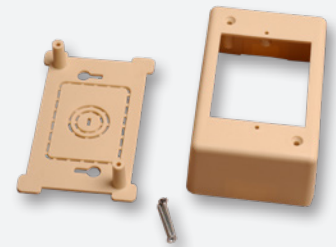

Surface Mount Junction Box - Single Gang

Each

White	99581K
Ivory	99580K
Office White	99584K

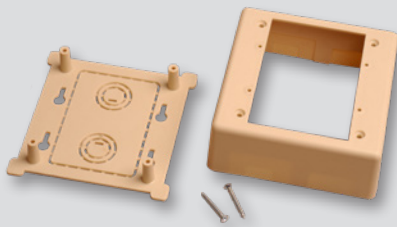

Surface Mount Junction Box - Double Gang

Each

White	99583K
Ivory	99582K
Office White	99585K

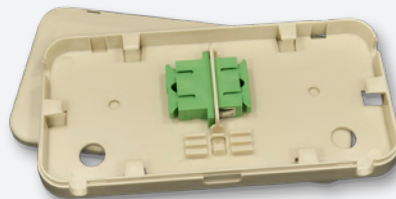

Fiber Wall Plate

Each

White	065-773-13
Ivory	065-773-11
Office White	065-773-12

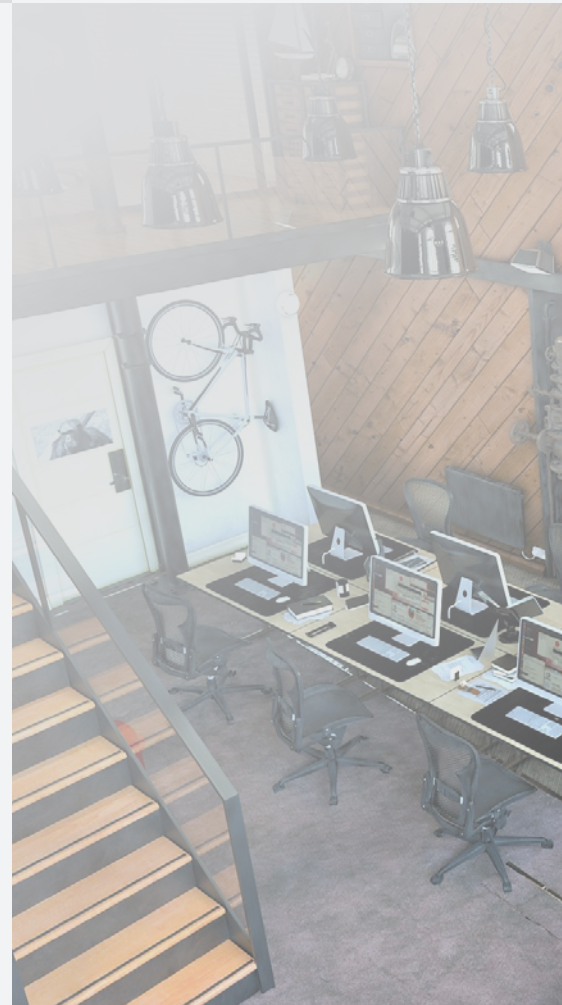

MRC30

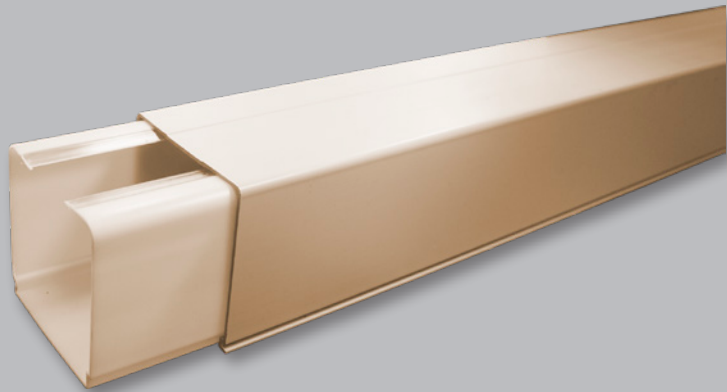

Molding - 8ft.
48 ft. / Carton

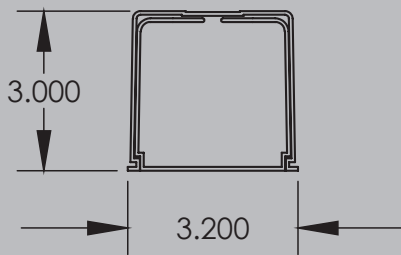

Ivory	039-686-10
-------	------------

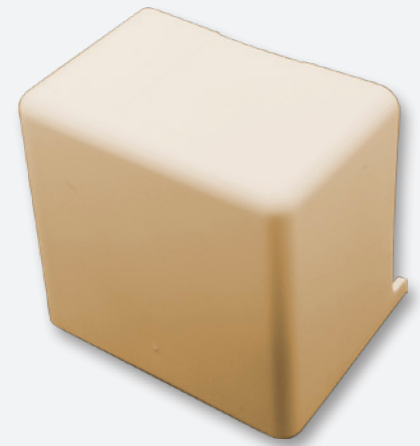

End Cap
10 / Pack

Ivory	039-688-20
-------	------------

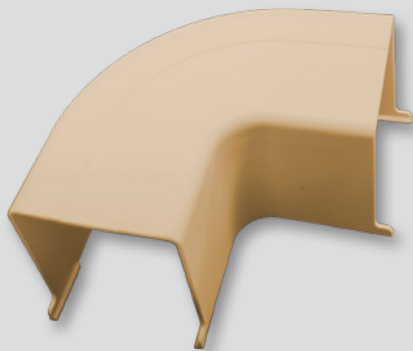

Flat Elbow
10 / Pack

Ivory	039-691-20
-------	------------

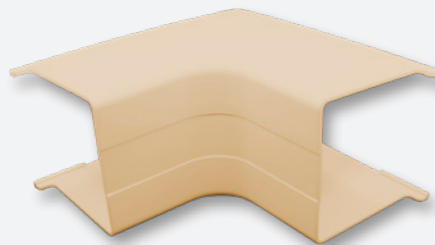

Inside Corner
10 / Pack

Ivory	039-690-20
-------	------------



Outside Corner
10 / Pack

Ivory	039-682-20
-------	------------



Seam Cover

10/Pack

Ivory	039-693-20
-------	------------

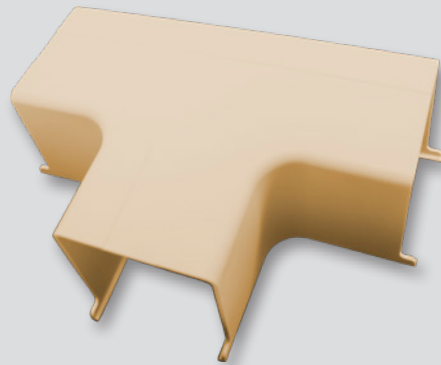

T Fitting

10/Pack

Ivory	039-689-20
-------	------------



T Reducer 3" to 1.75"

10/Pack

Ivory	039-687-20
-------	------------



Reducer 3" to 1.75"

10/Pack

Ivory	039-694-20
-------	------------

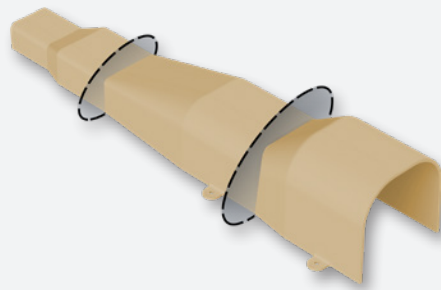

Transition Fitting

Scored sections for 1.25" & 1.75" reductions

Ivory	649-259-20
-------	------------





Cove Molding

Multilink's Plastic Cove Molding System is a 2 piece design in which the molding can be used to route and protect cabling for low voltage data, voice, video, and fiber optic applications. Fittings are available for routing direction changes, extending, and terminating the molding. All bases incorporate a 1" minimum bend radius as recommended for fiber optic cables. The molding is manufactured using a special purpose profile extrusion alloy resin and the fittings are manufactured using an injection grade resin. The product can be painted with latex paint.

2" Cove Molding

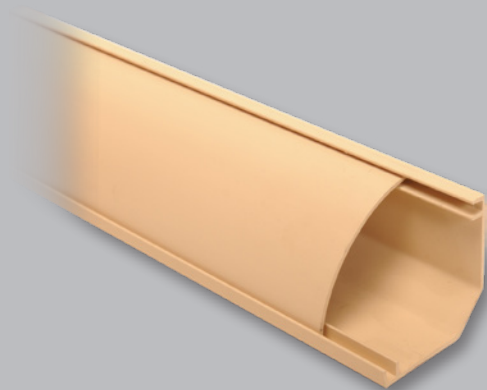

Molding - 8ft.
320 ft. / Carton

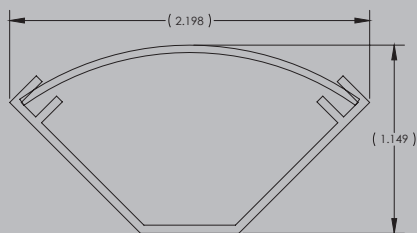

White	22678
Beige	22677



End Cap Left
Each

White	28389
Beige	28388



End Cap Right
Each

White	039-463-10
Beige	039-462-10



Outside Elbow
Each

White	28189
Beige	28177



Inside Elbow
Each

White	28079
Beige	28077

2.75" Cove Molding

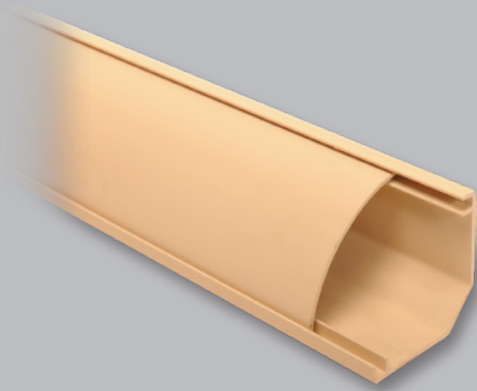

Molding - 8ft.
240 ft. / Carton

White	22696
Beige	22697
Linen White	039-541-10



End Cap Left
Each

White	28398
Beige	28397
Linen White	039-544-10



End Cap Right
Each

White	039-473-10
Beige	039-472-10
Linen White	039-545-10



Outside Elbow
Each

White	28189
Beige	28187
Linen White	039-543-10



Inside Elbow
Each

White	28088
Beige	28087
Linen White	039-542-10



Quarter Round

What is truly unique about Multilink's Raceway Molding system, with an emphasis on Ground Mounted Quarter Round, is that they are designed and built specifically for fiber optic cable. This is the reason why Multilink is the first choice by the top 5 telecommunication operators when purchasing molding for both their outside and inside plant. Some of our unique moldings are the Downspout Raceway System and our newly patented Micro Molding™. Our Raceway Molding systems are fast, simple, easy, and re-enterable. They are made to comply with UL listed specifications.

Quarter Round

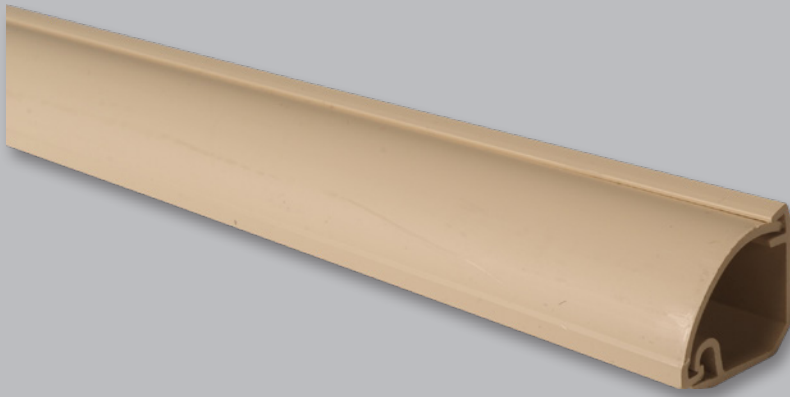

Molding - 8ft.

320 ft. / Carton

White	039-187-22
Ivory	039-187-21



End Cap Left

10 / Pack

White	039-219-22
Ivory	039-219-21



End Cap Right

10 / Pack

White	039-218-22
Ivory	039-218-21



Outside Elbow

10 / Pack

White	039-216-22
Ivory	039-216-21



Inside Elbow

10 / Pack

White	039-215-22
Ivory	039-215-21



T Fitting

10/Pack

White	039-217-22
Ivory	039-217-21



Seam Cover

10/Pack

White	039-214-22
Ivory	039-214-21





Hinged Overlay

Multilink Hinged Overlay Molding Raceway System is a 2 piece design with a base and cover. The molding can be used to route and protect cabling for low voltage data, voice, video, and fiber optic applications. Fittings are available for routing direction changes, extensions, and termination of the molding. All fittings incorporate a 1" minimum bend radius as recommended for fiber optic cables. The molding is manufactured using a special purpose profile extrusion alloy resin and the fittings are manufactured using an injection grade resin. The product is easily painted with latex paint.

Hinged Overlay

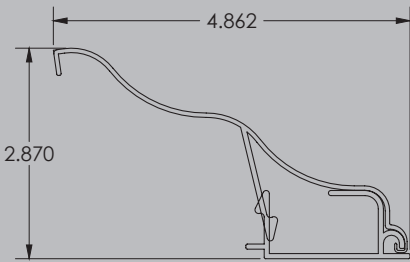
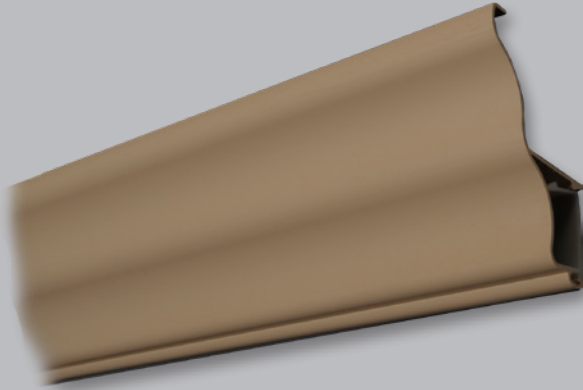

Molding - 8ft.
80 ft. / Carton

White	649-065-12
Ivory	649-065-11
Linen White	649-065-10

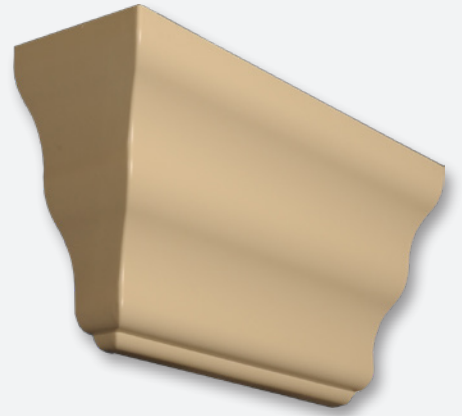

End Cap Left
10 / Pack

White	649-053-22
Ivory	649-053-21
Linen White	649-053-20

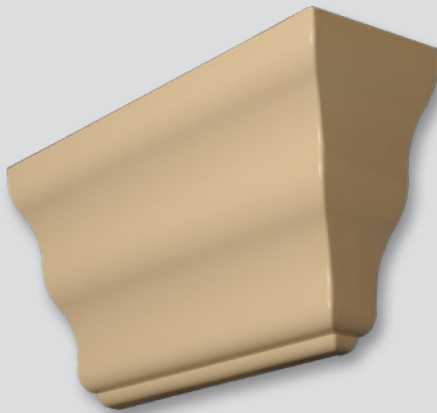

End Cap Right
10 / Pack

White	649-054-22
Ivory	649-054-21
Linen White	649-054-20

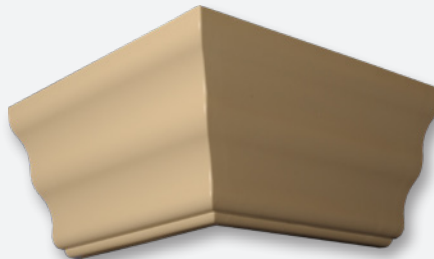

Outside Elbow w/ Bend Radius
10 / Pack

White	039-404-12
Ivory	039-404-11
Linen White	039-404-10

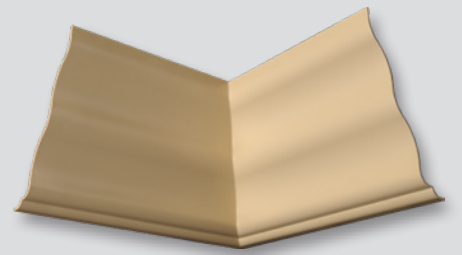

Inside Elbow w/ Bend Radius
10 / Pack

White	039-405-12
Ivory	039-405-11
Linen White	039-405-10

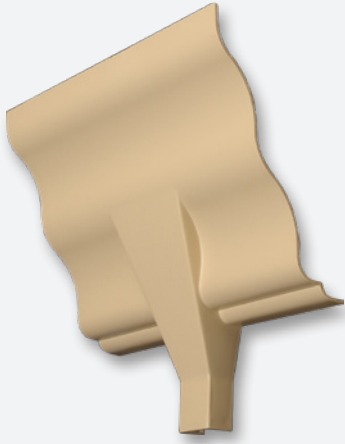

T Fitting w/ Bend Radius
to .75" raceway
10 / Pack

White	039-406-12
Ivory	039-406-11
Linen White	039-406-10



Seam Cover
10 / Pack

White	649-060-22
Ivory	649-060-21
Linen White	649-060-20





Flat Box

Multilink's Flat Box Plastic Raceway System is a 2 piece design that hinges open for installation access. The molding can be used to route and protect cabling for low voltage data, voice, video, and bend insensitive fiber optic applications. Fittings are available for routing direction changes, extending, and terminating the molding. The molding is manufactured using a special purpose profile extrusion alloy resin and the fittings are manufactured using an injection grade resin. The product can be painted with latex paint.

.75" Flat Box



Molding - 8ft.

192 ft. / Carton

White	23216
Beige	23217



Flat Elbow

Each

White	28220
Beige	28217

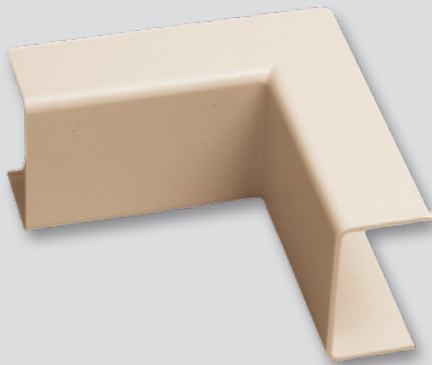

Inside Elbow

Each

White	28023
Beige	28017

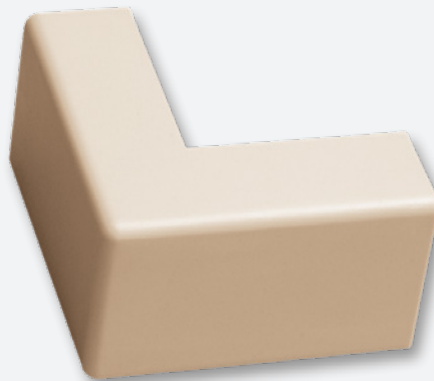

Outside Elbow

Each

White	28121
Beige	28117



1.25" Flat Box

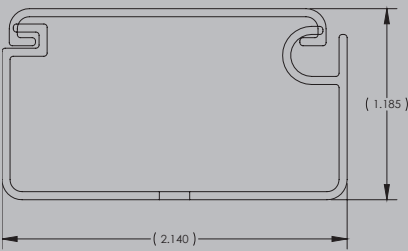

Molding - 8ft.

144 ft. / Carton

White	23235
Beige	23237

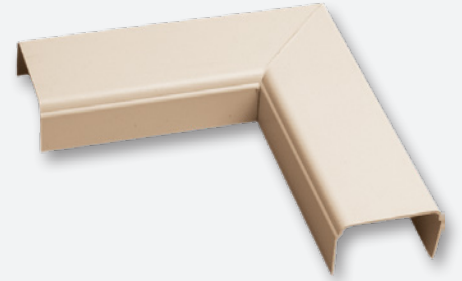

Flat Elbow

Each

White	28245
Beige	28249

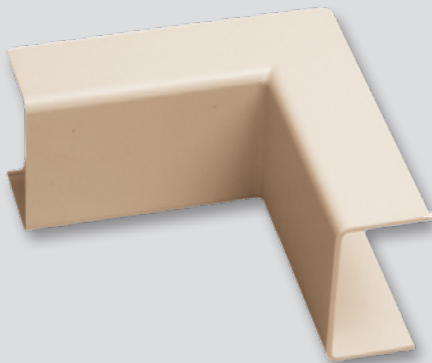

Inside Elbow

Each

White	28036
Beige	28037

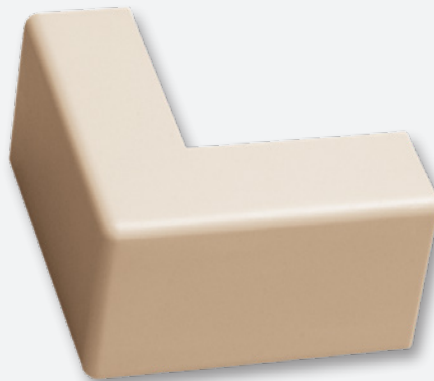

Outside Elbow

Each

White	28136
Beige	28137



2" Flat Box

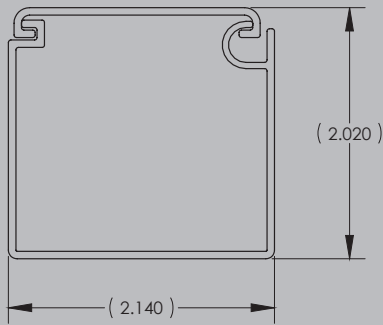

Molding - 8ft.

64 ft. / Carton

White	23266
Beige	23267



Flat Elbow

Each

White	28279
Beige	28277

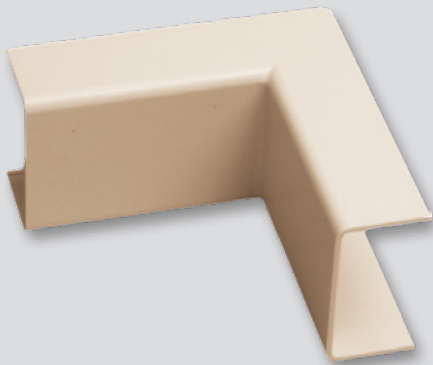

Inside Elbow

Each

White	28066
Beige	28067

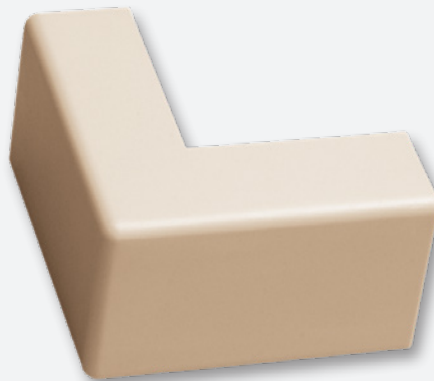

Outside Elbow

Each

White	28166
Beige	28167



2.5" Flat Box

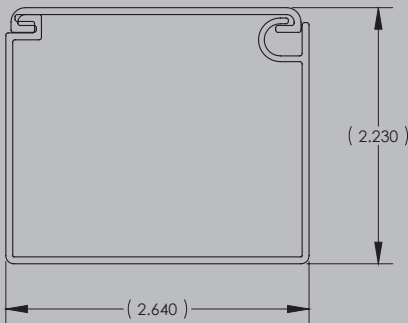

Molding - 8ft.
64 ft. / Carton

White	25973
Beige	25974

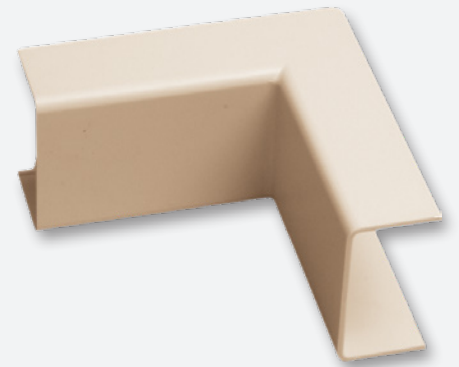

Inside Elbow
Each

White	10-6072
Beige	039-408-10

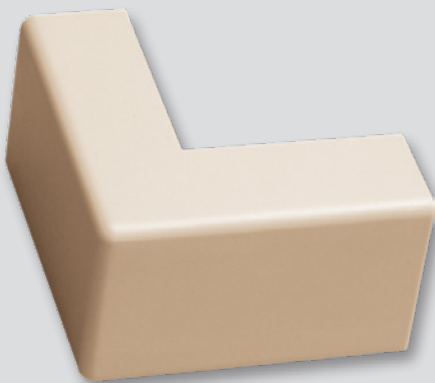

Outside Elbow
Each

White	10-6073
Beige	039-409-10



67 | OUTDOOR PLASTIC

DOWNSPOUT	68
<i>DOWNSPOUT</i>	69
MULTICLEAR EXTERIOR	71
<i>MRC12-E</i>	72
<i>MRC17-E</i>	75
<i>MRC30-E</i>	78



Downspout

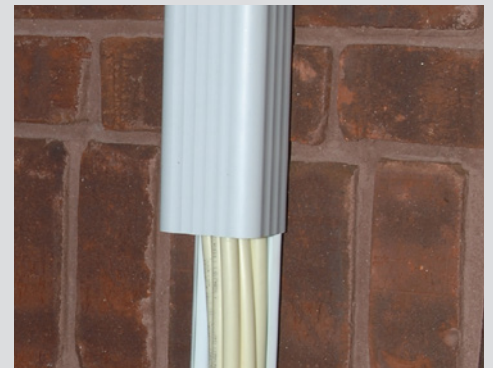
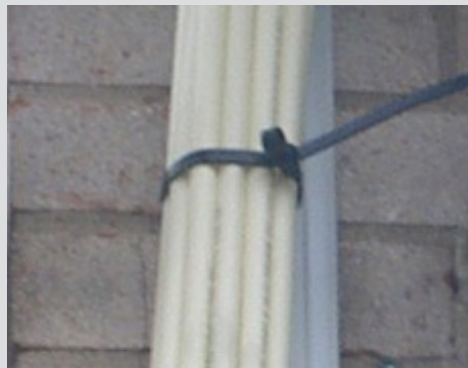

The patented Downspout Raceway System from Multilink provides a simple solution to cover up any wiring or piping that runs along your exterior walls. This system gives you the added benefits of maintaining the accepted architecture look that will be readily accepted by the end user as well as a quick and easy installation in the field.

Downspout

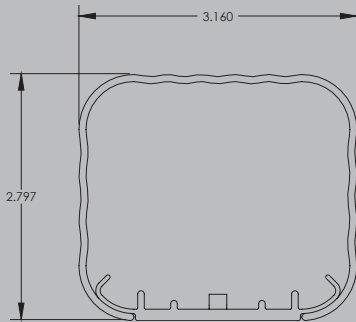
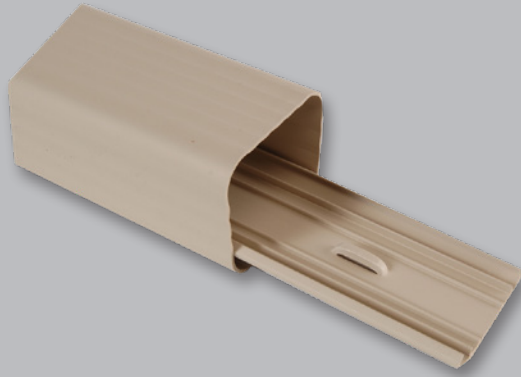

Molding - 8ft.

96 ft. / Carton

White	039-138-10
Exterior Ivory	039-138-12
Brown	039-138-11

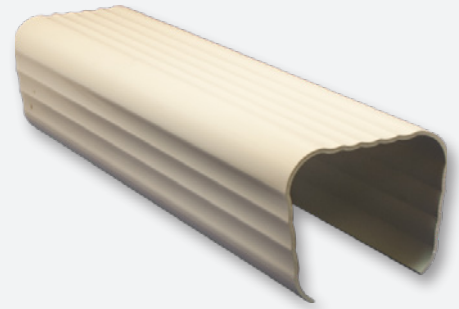

Seam Cover

10 / Pack

White	039-141-10
Exterior Ivory	039-141-12
Brown	039-141-11



End Cap

10 / Pack

White	039-139-10
Exterior Ivory	039-139-12
Brown	039-139-11



Wall Strap

10 / Pack

White	039-143-10
Exterior Ivory	039-143-12
Brown	039-143-11



90° Fitting

Each

White	039-146-10
Exterior Ivory	039-146-12
Brown	039-146-11



45° Fitting

Each

White	039-147-10
Exterior Ivory	039-147-12
Brown	039-147-11



4" Downspout to Round Adapter

Each

White	039-163-10
--------------	------------



3" Downspout to Round Adapter

Each

White	039-164-10
--------------	------------





MultiClear Exterior

Multilink's MultiClear Exterior Plastic Track Molding is a 2 piece design with a base cover. The molding can be used to route and protect cabling for low voltage data, voice, video, and fiber optic applications. Fittings are available for routing direction changes, extensions, and termination of the molding. All bases incorporate a 1" minimum bend radius as recommended for fiber optic cables. The molding is manufactured using a special purpose profile extrusion alloy resin and the fittings are manufactured using an injection grade resin. The product is easily painted with latex paint.

MRC12-E

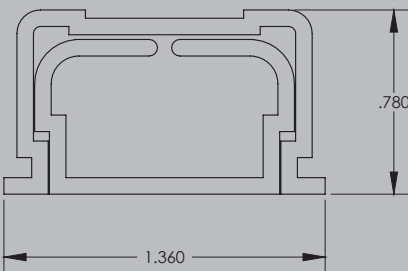
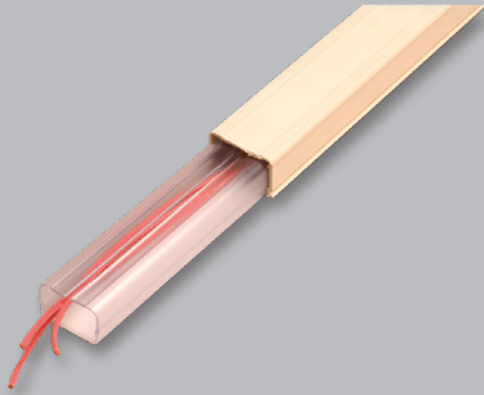

Molding - 8ft.
160 ft. / Carton

White	039-302-20
Exterior Ivory	10-9465

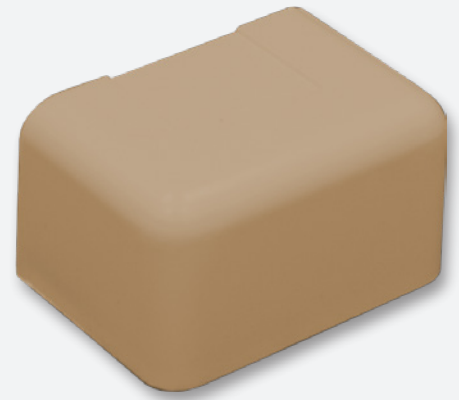

End Cap
10 / Pack

White	039-264-20
Exterior Ivory	10-9729



Flat Elbow
10 / Pack

White	039-259-10
Exterior Ivory	10-9419

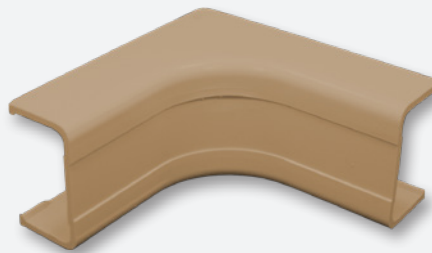

Inside Elbow
10 / Pack

White	039-253-10
Exterior Ivory	10-9415

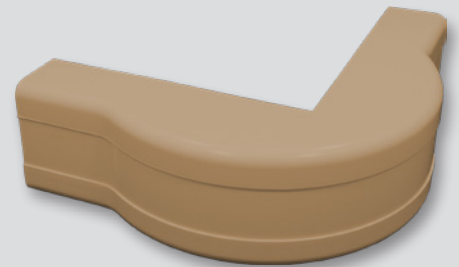

Outside Elbow
10 / Pack

White	039-256-10
Exterior Ivory	10-9417

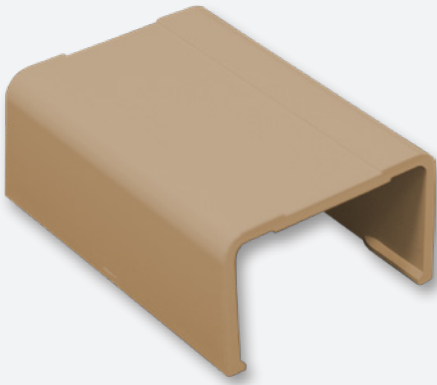

Seam Cover

10/Pack

White	039-263-20
Exterior Ivory	10-9421



T Fitting

10/Pack

White	039-262-10
Exterior Ivory	10-9731



Transition Fitting

10/Pack

White	649-052-23
Exterior Ivory	649-052-10



Ceiling Entry

10/Pack

White	039-265-20
Exterior Ivory	039-175-20



Slack Box Entry

10/Pack

White	039-284-20
Exterior Ivory	039-208-20



Slack Storage Box

Each

White	020-051-10
Exterior Ivory	020-004-24



**Slack Storage Box w/ 3
Holes**
Each

Exterior Ivory	020-004-23
----------------	------------



MRC17-E

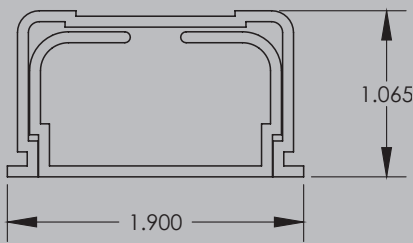
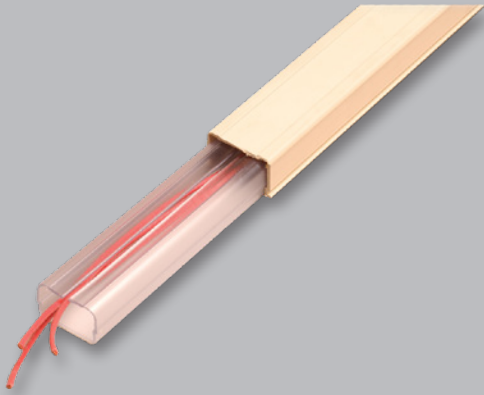

Molding - 8ft.

160 ft. / Carton

White	039-303-20
Exterior Ivory	10-9423

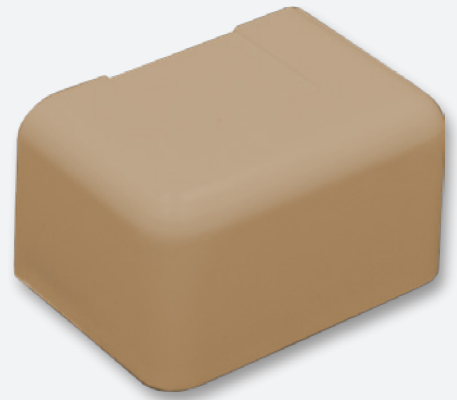

End Cap

10 / Pack

White	039-280-20
Exterior Ivory	10-9730



Flat Elbow

10 / Pack

White	039-275-10
Exterior Ivory	10-9429

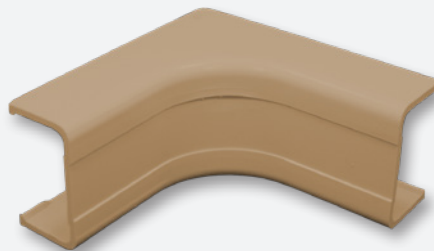

Inside Elbow

10 / Pack

White	039-269-10
Exterior Ivory	10-9425

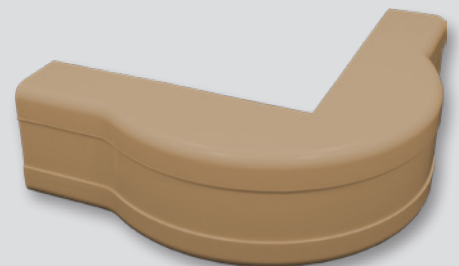

Outside Elbow

10 / Pack

White	039-272-10
Exterior Ivory	10-9427

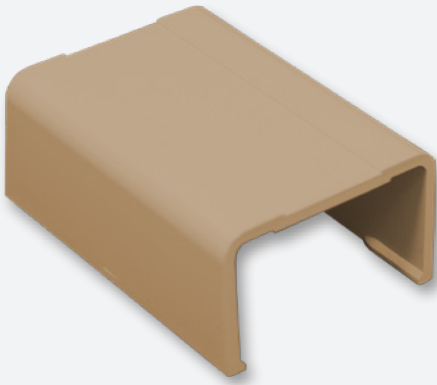

Seam Cover

10/Pack

White	039-279-20
Exterior Ivory	10-9431



T Fitting

10/Pack

White	039-278-10
Exterior Ivory	10-9734



Transition Fitting

10/Pack

White	649-051-23
Exterior Ivory	649-051-10



Ceiling Entry

10/Pack

White	039-281-20
Exterior Ivory	039-176-20



Slack Box Entry

10/Pack

White	039-285-20
Exterior Ivory	039-209-20



Slack Storage Box

Each

White	020-052-10
Exterior Ivory	020-004-24



**Slack Storage Box w/ 3
Holes**
Each

Exterior Ivory	020-004-23
----------------	------------



MRC30-E



Molding - 8ft.

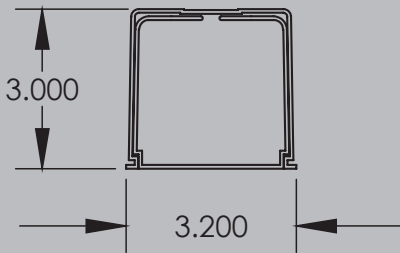

Exterior Ivory	039-676-10
----------------	------------



End Cap

10 / Pack

Exterior Ivory	039-678-20
----------------	------------

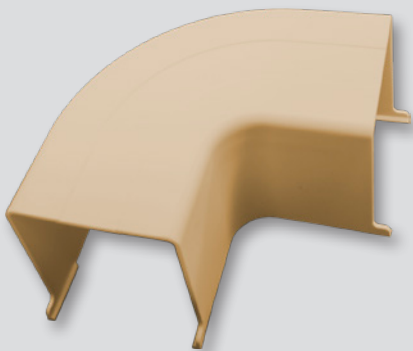

Flat Elbow

10 / Pack

Exterior Ivory	039-681-20
----------------	------------

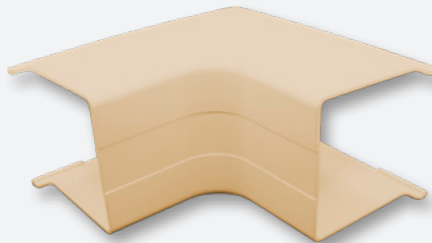

Inside Corner

10 / Pack

Exterior Ivory	039-680-20
----------------	------------



Outside Corner

10 / Pack

Exterior Ivory	039-682-20
----------------	------------



Seam Cover

10/Pack

Exterior Ivory	039-683-20
----------------	------------

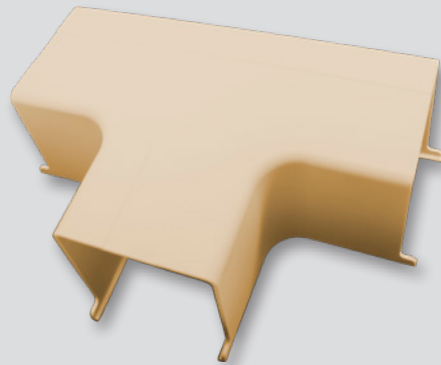

T Fitting

10/Pack

Exterior Ivory	039-679-20
----------------	------------

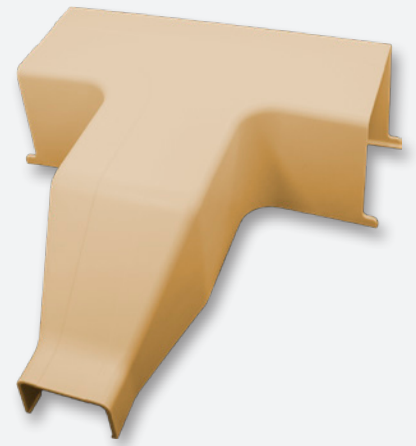

T Reducer 3" to 1.75"

10/Pack

Exterior Ivory	039-677-20
----------------	------------



Reducer 3" to 1.75"

10/Pack

Exterior Ivory	039-684-20
----------------	------------

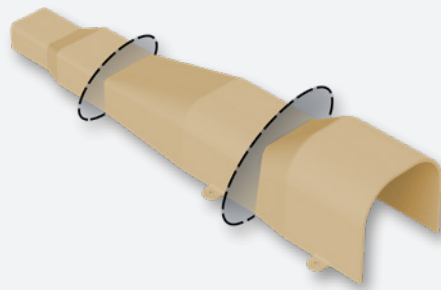

Transition Fitting

Scored sections for 1.25" & 1.75" reductions

Exterior Ivory	649-259-20
----------------	------------





580 Ternes Ln. Elyria, OH 44035
Phone: 440.366.6966
Email: engsupport@gomultilink.com